

Thermoplastic Extruded Profiles

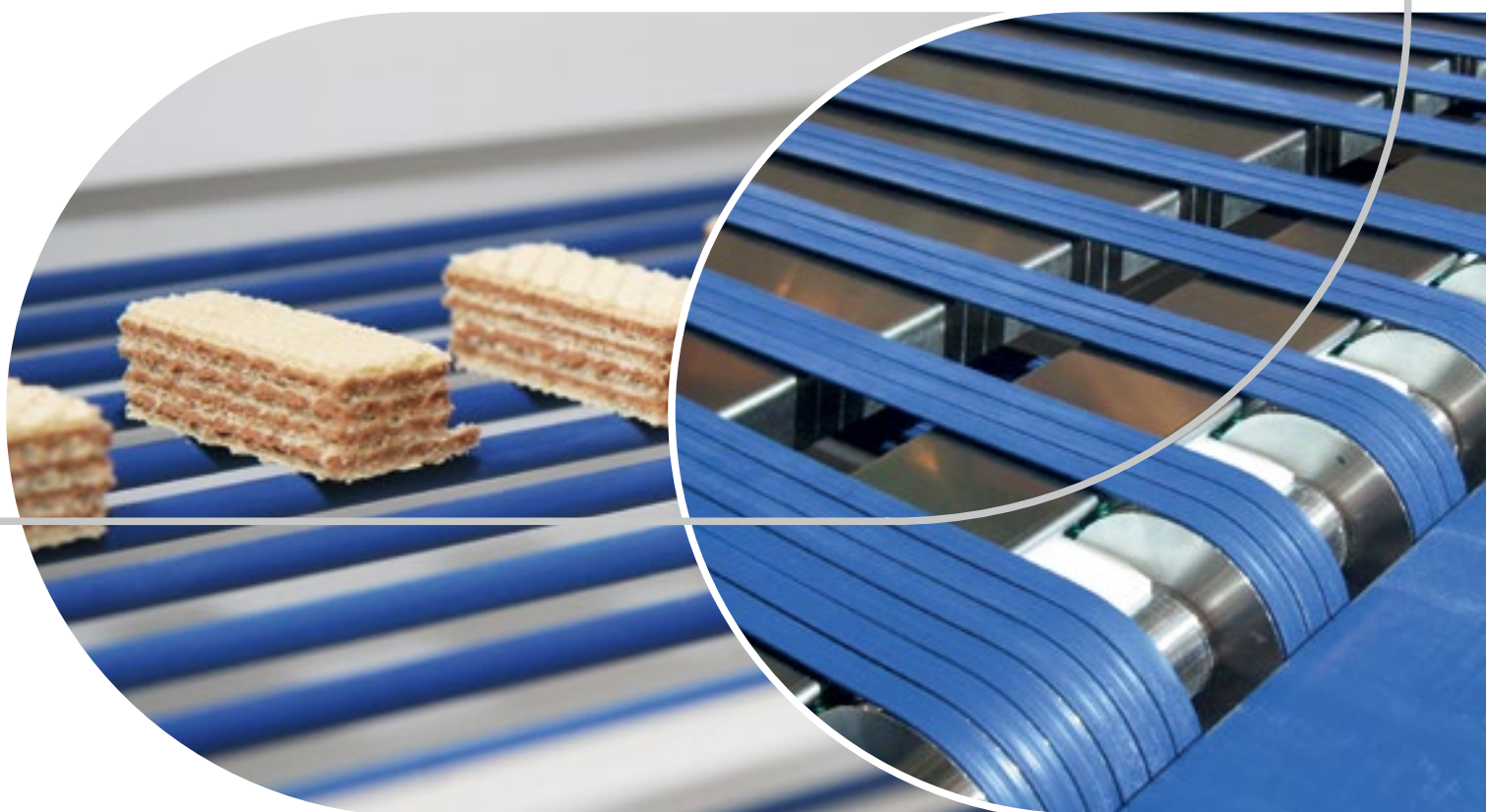

Introduction	3
Product code	4
Round belts	6
Special round belts	7
Molded round belts	8
V-belts	9
T-belts	10
Flat belts and HabaSYNC® covers	11
Structured flat belts	12
PVC and TPEE Flat belts	13
Belt accessories	14
Belt accessories – Cleats	14
Belt accessories – Tracking guides	17
Belt accessories – Edge sealing	20
Belt accessories – Sidewalls	21
Details	22
Details – Round belts	22
Details – V-shape belts	25
Details – Cleats	28
Details – Cleats / Tracking guides	32
Details – Tracking guides	33
Engineering guides	36
Accessories	38
Accessories – Cutting	38
Accessories – Quickmelt joining tools	39
Solutions in motion	40
Contacts	44

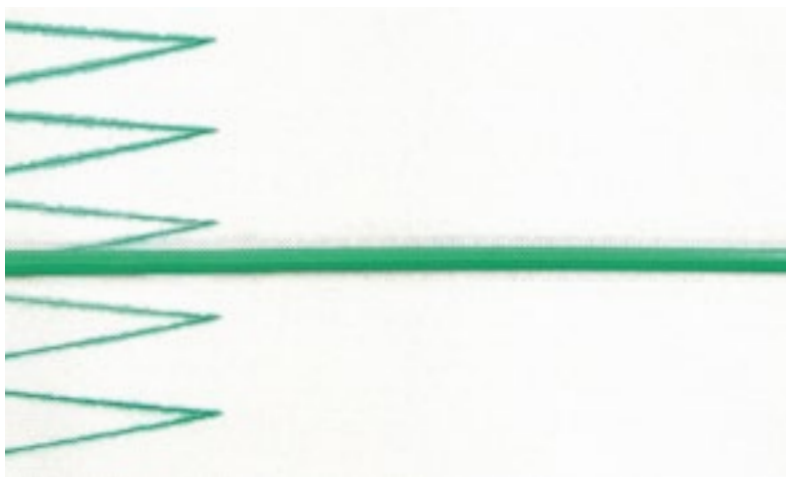
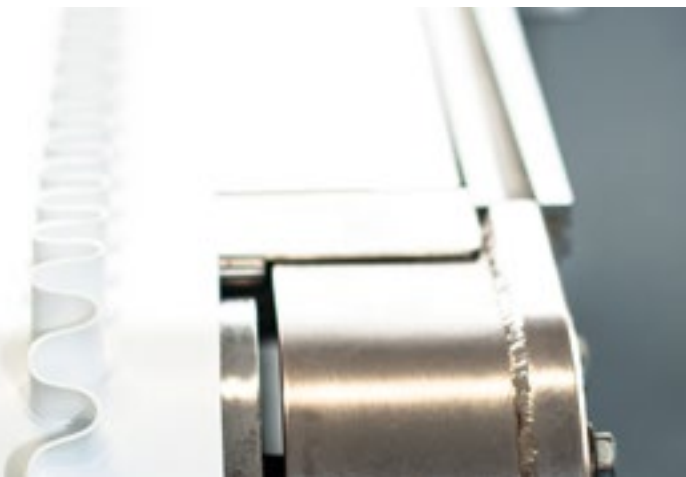

Conveying goods can be a complex and diverse process. Depending on the type of product, optimization of the line and efficiency of the conveying process require a high degree of belt customization. Habasit range of thermoplastic belts and belt accessories, including tracking guides, cleats, sidewalls and flat profiles for edge sealing allows you to find the right solution for your requirements.

Habasit round belts are highly flexible, directionally adjustable, and multi-directional for angular gears. They can be used for conveying as well as for driving applications. As a result of their elasticity, round belts can be installed without a tensioning device. This allows compact machine designs. In addition, the elasticity acts as a security element by reducing shocks in case of brief overloads.

Trapezoidal and other shaped belts are tailor-made to suit specific industry and application needs or machine designs. Offered in three different shapes - V, T and flat - these belts are used on linear conveyors, in diverter applications, and, as an accessory for fabricated belts to support smooth and reliable operation.

Thermoplastic profiles and cleats are primarily used in general conveying on inclining or declining transport in linear movement, or in applications where transversal forces occur. Profiles can be added to conveyor and processing belts, as well as to HabaSYNC® timing belts, to assist conveying and product placement. Cleats, tracking guides, and side walls are available in a variety of sizes and materials that offer enhanced features for your custom design.

Belts are produced in different materials (polyurethane, hydrolysis resistant polyurethane, PVC), different thicknesses and with various surface properties. Specific Food grade TPU and PVC compounds with EU and FDA certifications have been developed for food contact applications.



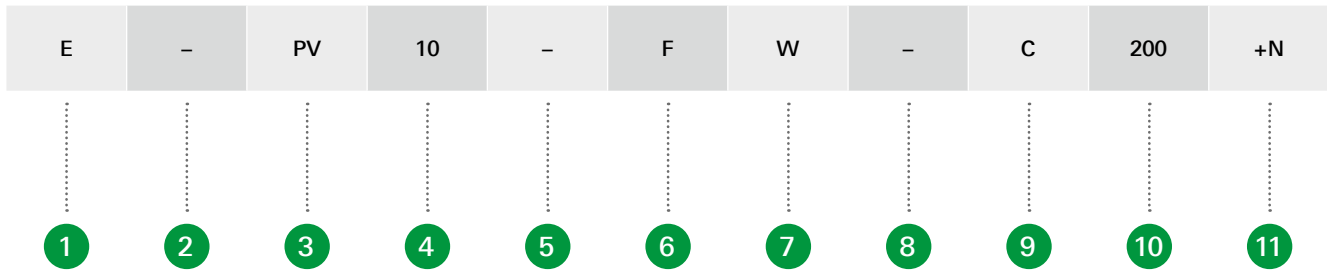

1 Code digit – Manufacturing technology

E	Extruded products
M	Molded (Habiring)

2 Interruption (= reading aid)

3 Code digit 2 letters – Profile shape

FB	Flat belts
PB	Profile – Narrow base bent flight
PE	Profile – Edge sealing profile
PI	Profile – Finger
PL	Profile – Habibord
PN	Profile – Narrow base flight
PP	Profile – Power turn
PQ	Profile – Rectangular
PS	Profile – Scoop
PT	Profile – T-shape
PU	Profile – Flat tracking guide (ex pug)
PV	Profile – V-shape tracking guide
PW	Profile – Welding rod
RB	Round belt – Standard
RR	Round belt – Reinforced
TT	T-shape belt
VT	V-shape belt – Standard
VR	V-shape belt – Reinforced
VC	V-shape belt – Crested
VS	V-shape belt – Reinforced + crested
VU	V-shape belt – Raised

4 Code digit – Biggest dimension

13-50	Flat belts. 10x Thickness of the flat belt in mm
04-105	Profiles – Cleats. Height of the profile in mm
06-30	V-Guides & V-Belts. Width of the profile in mm
2.0x118- 7.0x445	Habiring. Diameter and Belt Length in mm

5 Interruption (= reading aid)

6 Code digit 1 letter – Material

C	TPO 85ShA (F)
E	TPEE 55ShA (F)
F	Polyester TPU 85ShA (F)
G	Polyether TPU 83ShA (F)*
H	Polyether TPU 87ShA (F) **
J	Polyether TPU 95ShA (F) **
K	Polyester TPU 85ShA
L	Polyester TPU 85ShA – Extra elastic
O	PVC 55ShA
R	PVC 65ShA (F)
S	PVC 65ShA
T	Polyester TPU 92ShA
U	Polyester TPU 75ShA
W	Polyester TPU 63ShA
X	Special – See notes
Y	TPU 95ShA (F)

(F) = Food grade

* dedicated to new Habasit TPU food belts

** dedicated to Habasit® Cleandrive range

7 Code digit 1 letter – Color

A	Anthracite	N	Natural
B	Black	O	Orange
C	Cobalt blue	P	Apple green
D	Dark green	R	Red
E	Beige	S	Light blue
F	Off-white	T	Transparent
G	Green	U	Umber brown
H	Honey	V	Light green
I	Bluish	W	White
K	Golden	Y	Yellow
L	Light gray	X	Special*
M	Gray		

*Comments will follow on product name

8 Interruption (= reading aid)

9 Code digit 1 letter – Packaging type

C	Coil
B	Box

10 Code digit – Packaging quantity → 200 m Length

11 Code digit – Options

E	Embossed
G	Grip
M	Metal detectable
N	Notched
NN	Special notched
R	Rough surface
S	Smooth surface

Key to material abbreviations

PVC = Polyvinyl chloride







TPEE = Thermoplastic copolyester

TPO = Thermoplastic polyolefin





















TPU = Polyester thermoplastic polyurethane

TPU+ = Polyether thermoplastic polyurethane

Key to symbols

	Sand-finish
	Sand-finish reinforced
	Smooth
	Rough
	Grip top
	Grip top reinforced

Profile shape – Symbols

	FB Flat belts
	PB Profile – Narrow base bent flight
	PE Profile – Edge sealing profile
	PI Profile – Finger
	PL Profile – Habibord
	PN Profile – Narrow base flight
	PP Profile – Power turn
	PQ Profile – Rectangular
	PS Profile – Scoop
	PT Profile – T-shape
	PU Profile – Flat tracking guide (ex pug)
	PV Profile – V-shape tracking guide
	PW Profile – Welding rod
	RB Round belt – Standard
	RR Round belt – Reinforced
	TT T-shape belt – Single T / Double T
	VT V-shape belt – Standard
	VR V-shape belt – Reinforced
	VC V-shape belt – Crested
	VS V-shape belt – Reinforced + crested
	VU V-shape belt – Raised

The Habasit round belts range offers a wide selection of standard, Food grade and hydrolysis resistant sand-finish TPU belts, with a choice of different surface finishes and textile yarn reinforcement configurations.

Open end – standard

- Polycord® – Made in Switzerland
- Habicord – Optionally in rough, smooth and reinforced versions

Open end – Food grade

- Polywhite – Food grade and high wear resistance
- Habibblue – Polyether TPU, hydrolysis resistant round belts





Molded – standard

- Habiring – Endless molded round belts



Applications:

Standard: textile, packaging, paper, ceramics and wood industries; live roller drives and linear conveyors
 Hydrolysis resistant: bakery, meat and cheese processing

Brand	Polycord®	Habicord	Habibblue	Polywhite
				
Material	TPU	TPU	TPU+	TPU
Hardness	87ShA	87ShA	87ShA	87ShA
Color	Green	Green	Cobalt blue	White
Surface	Sand-finish	Sand-finish	Sand-finish	Sand-finish
Food grade			•	•
Hydrol. Resist.			•	
Ø [mm]	Product name			
3	E-RB03-KG	E-RB03-KG-C300	E-RB03-HC-C300	E-RB03-FW-C300
4	E-RB04-KG	E-RB04-KG-C250	E-RB04-HC-C250	E-RB04-FW-C250
5	E-RB05-KG	E-RB05-KG-C250	E-RB05-HC-C250	E-RB05-FW-C250
6	E-RB06-KG	E-RB06-KG-C250	E-RB06-HC-C250	E-RB06-FW-C250
7	E-RB07-KG	E-RB07-KG-C200		E-RB07-FW-C200
8	E-RB08-KG	E-RB08-KG-C200	E-RB08-HC-C200	E-RB08-FW-C200
10	E-RB10-KG	E-RB10-KG-C100	E-RB10-HC-C100	E-RB10-FW-C100
12	E-RB12-KG	E-RB12-KG-C100	E-RB12-HC-C100	E-RB12-FW-C100
15	E-RB15-KG	E-RB15-KG-C50		E-RB15-FW-C50
18		E-RB18-KG-C50		
20		E-RB20-KG-C50		

Brand	Rough Habicord	Smooth Habicord	Reinforced Habicord
	R	S	
Material	TPU	TPU	TPU
Hardness	87ShA	87ShA	87ShA
Color	Green	Green	Cobalt blue
Surface	Rough	Smooth	Sand-finish
Ø [mm]	Product name		
2	E-RB02-KG-C600+R		
3	E-RB03-KG-C300+R		
4	E-RB04-KG-C250+R		E-RR04-KC-C250
5	E-RB05-KG-C250+R	E-RB05-KG-C250+S	
6	E-RB06-KG-C250+R	E-RB06-KG-C250+S	E-RR06-KC-C250
w	E-RB08-KG-C200+R	E-RB08-KG-C200+S	
10		E-RB10-KG-C100+S	E-RR10-KC-C100
12	E-RB12-KG-C100+R	E-RB12-KG-C100+S	E-RR12-KC-C100
15	E-RB15-KG-C50+R		

Surface finishings







Smooth



Regular (Sand-finish)



Rough

Brand		Habiring			
					
Material		TPU	TPU	TPU	TPU
Hardness		87ShA	87ShA	87ShA	87ShA
Color		Cobalt blue	Green	Natural	Yellow
Ø [mm]	L [mm]	Product name			
2.0	118		M-RB2.0x118-KG-B1000		
	128		M-RB2.0x128-KG-B1000		
	147		M-RB2.0x147-KG-B1000		
2.5	78	M-RB2.5x078-KC-B1000	M-RB2.5x078-KG-B1000		M-RB2.5x078-KY-B1000
2.7	268	M-RB2.7x268-KC-B1000			M-RB2.7x268-KY-B1000
	307	M-RB2.7x307-KC-B1000			M-RB2.7x307-KY-B1000
3.0	140		M-RB3.0x140-KG-B1000		
	155		M-RB3.0x155-KG-B1000		
	175		M-RB3.0x175-KG-B1000	M-RB3.0x175-KN-B1000	
	245		M-RB3.0x245-KG-B1000		
3.2	133		M-RB3.2x133-KG-B1000		
3.5	207			M-RB3.5x207-KN-B1000	
4.0	112		M-RB4.0x112-KG-B1000		
	122		M-RB4.0x122-KG-B1000		
	258	M-RB4.0x258-KC-B1000			
5.0	123		M-RB5.0x123-KG-B1000		
	182		M-RB5.0x182-KG-B1000		
	196		M-RB5.0x196-KG-B1000		
6.0	95		M-RB6.0x095-KG-B1000		
	119		M-RB6.0x119-KG-B1000		
	130		M-RB6.0x130-KG-B1000		
	142		M-RB6.0x142-KG-B1000		
	200		M-RB6.0x200-KG-B1000		
6.5	445		M-RB6.5x445-KG-B1000		
7.0	119		M-RB7.0x119-KG-B1000		
	128		M-RB7.0x128-KG-B1000		
	130		M-RB7.0x130-KG-B1000		
	170		M-RB7.0x170-KG-B1000		
	173		M-RB7.0x173-KG-B1000		

V-belts are highly flexible V-shaped smooth TPU belts running over pulleys compliant with DIN2215. They are used in linear conveyors, especially in the ceramics and materials handling industries.





Features

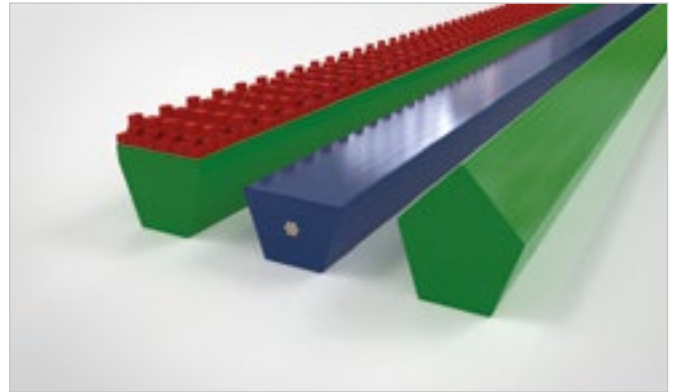

- High abrasion and chemical resistance
- Easy to weld

Options

- Reinforced
- Grip top (with grip cover)
- Crested top
- Raised top







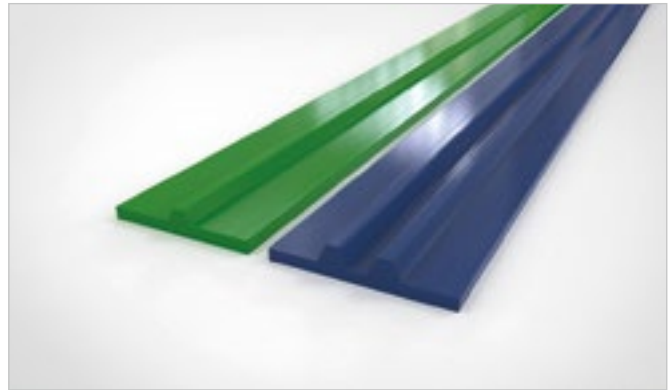

Type	Standard	Grip top	Reinforced	Reinforced + grip top
				
Material	TPU	TPU	TPU	TPU
Hardness	87ShA	87ShA	87ShA	87ShA
Color	Green	Green	Cobalt blue	Cobalt blue
Surface	Smooth	Smooth	Smooth	Smooth
DIN 2215 B [mm]	ISO 4184 equivalent	Product name		
10	Z	E-VT10-KG-C200	E-VT10-KG-C50+G	
13	A	E-VT13-KG-C100	E-VT13-KG-C50+G	E-VR13-KC-C100
17	B	E-VT17-KG-C50	E-VT17-KG-C50+G	E-VR17-KC-C50
22	C	E-VT22-KG-C50	E-VT22-KG-C50+G	E-VR22-KC-C50

Type	Crested	Crested + reinforced	Raised
			
Material	TPU	TPU	TPU
Hardness	87ShA	87ShA	87ShA
Color	Green	Cobalt blue	Green
Surface	Smooth	Smooth	Smooth
B [mm]	Product name		
10			E-VU10-KG-C100
13			E-VU13-KG-C100
17	E-VC17-KG-C100	E-VS17-KC-C50	E-VU17-KG-C50
22	E-VC22-KG-C30	E-VS22-KC-C50	

Habasit offers narrow flat belts with one or two tracking guides integrated on the running side, available in standard and Food grade smooth TPU.

Applications: linear conveyors and diverters



Single T						
						
Material	TPU+	TPU+	TPU+	TPU+	TPU	TPU
Hardness	87ShA	87ShA	83ShA	83ShA	85ShA	85ShA
Color	Cobalt blue	White	Cobalt blue	White	Green	White
Surface	Smooth	Smooth	Smooth	Smooth	Smooth	Smooth
Food grade	•	•	•	•		
Hydrol. Resist.	•	•	•	•		
B [mm]	Product name					
12			E-TT12-GC-C200	E-TT12-GW-C200		E-TT12-KW-C50
25	E-TT25-HC-C100	E-TT25-HW-C100			E-TT25-KG-C200	E-TT25-KW-C50





Double T	
	
Material	TPU+
Hardness	87ShA
Color	Cobalt blue
Surface	Smooth
Food grade	•
Hydrol. Resist.	•
B [mm]	Product name
28	E-TT28-HC-C100







Covers provide the friction needed to handle products so that they are correctly indexed and securely managed. Habasit's extruded TPU covers can be used in multiple applications and under most conditions.



They can provide a combination of features that include:

- Abrasion resistance
- Chemical resistance
- High or low coefficients of friction
- Food compliance
- Gentle movement
- Shock absorption



TPU flat belts					
					
Material	TPU+	TPU+	TPU+	TPU+	TPU
Hardness	95ShA	87ShA	87ShA	65ShA	92ShA
Color	Cobalt blue	Cobalt blue	White	Transparent	Natural
Food grade	•	•	•		
Hydrol. Resist.		•	•		
Thickness [mm]	Product name				
1.3		E-FB13-HC-C100	E-FB13-HW-C100	E-FB13-WT-C100	
1.6				E-FB16-WT-C100	
1.7					
2.0				E-FB20-WT-C100	E-FB20-TN-C100
2.2		E-FB22-HC-C100	E-FB22-HW-C100		
3.0				E-FB30-WT-C50	E-FB30-TN-C50
4.0				E-FB40-WT-C50	E-FB40-TN-C50
5.0	E-FB50-YC-C25	E-FB50-HC-C25	E-FB50-HW-C50	E-FB50-WT-C25	E-FB50-TN-C25

TPU flat belts						
						
Material	TPU	TPU	TPU	TPU	TPU	TPU
Hardness	85ShA	85ShA	85ShA	85ShA	85ShA	85ShA
Color	Cobalt blue	White	Green	Transparent	Yellow	Dark green
Food grade	•	•	•	•	•	•
Thickness [mm]	Product name					
1.3	E-FB13-FC-C100	E-FB13-FW-C100	E-FB13-FG-C100			E-FB13-FD-C100
1.6						
1.7		E-FB17-FW-C100				
2.0	E-FB20-FC-C100	E-FB20-FW-C100		E-FB20-FT-C100	E-FB20-FY-C100	
2.2						
3.0	E-FB30-FC-C50	E-FB30-FW-C50		E-FB30-FT-C50		
4.0		E-FB40-FW-C50				E-FB40-FD-C50
5.0	E-FB50-FC-C25	E-FB50-FW-C25				
		E-FB50-FW-C50				

		Structured TPU flat belts		
				
Material		TPU	TPU	TPU
Hardness		63ShA	85ShA	85ShA
Color		Red	Cobalt blue	Green
Food grade			•	
Emboss top	Emboss bot.	Product name		
S	H	E-FB20-WR-C100+E(S/H)	E-FB20-FC-C100+E(S/H)	
S	HT		E-FB20-FC-C100+E(S/HT)	
S	LG			E-FB20-KG-C100+E(S/LG)
S	T		E-FB20-FC-C100+E(S/T)	
EH	T		E-FB20-FC-C100+E(EH/T)	
EH	T		E-FB20-FB-C100+E(EH/T)	
HT	LG			E-FB20-KM-C100+E(HT/LG)

Thickness: 2,0 mm

Structures nomenclature



S / Smooth



HT / Cone Top



EH / Extra Fine







LG / Longitudinal Grooves

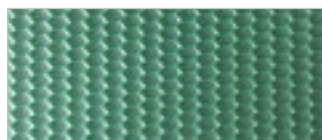

H / Fine



T / Honeycomb

PVC flat belts				
				
Material	PVC	PVC	PVC	PVC
Hardness	65ShA	65ShA	65ShA	65ShA
Color	Cobalt blue	White	Dark green	Anthracite
Food grade	•	•	•	
Thickness [mm]	Product name			
3.0				E-FB30-SA-C50
4.0	E-FB40-RC-C50	E-FB40-RW-C50	E-FB40-RD-C50	

TPEE flat belts	
	
Material	TPEE
Hardness	55ShA
Color	Red
Food grade	•
Hydrol. Resist.	•
Thickness [mm]	Product name
2.0	E-FB20-ER-C100
3.0	E-FB30-ER-C50

The Habasit accessories range for conveyor and processing belts includes:

- Cleats
- Tracking guides
- Edge sealing profiles
- Corrugated sidewalls

Belts equipped with transversal profiles are mainly used for inclined applications; sidewalls can be used together with these in order to contain bulk goods at the sides of the belt. Different shapes, colors, dimensions and material hardnesses are mostly available in TPU, but often also in PVC. Mounting is usually done by welding, and is carried out by a Habasit representative.

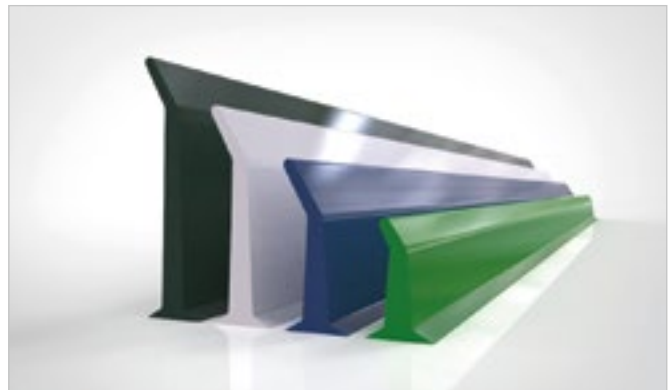

Accessories can be orientated, based on the application's needs, in many different configurations, for example:

- Transverse to the running direction for inclined or declined conveying or product placement
- Diagonally or staggered to the running direction for inclined or declined conveying or product placement
- Laterally as a side border to avoid products falling off the conveyor belt
- Along and above the running direction of the belt edges as a side skirt
- Mounted on the belt running side as a tracking guide to equalize or balance transversal forces



E-PN* Narrow

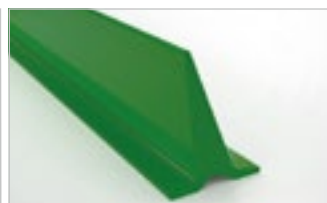

E-PT* Inclined



E-PS* Scoops











E-PB* Bent tip















E-PQ* Rectangular











E-PI* Fingers



	PT							
								
Material	TPU	TPU	TPU	PVC	PVC	PVC	PVC	PVC
Hardness	85ShA	85ShA	85ShA	65ShA	65ShA	65ShA	65ShA	65ShA
Color	Cobalt blue	White	Green	Cobalt blue	White	Dark green	Anthracite	Dark green
Food grade	•	•	•	•	•	•		
Height [mm]	Product name							
20	E-PT20-FC-B156	E-PT20-FW-B156	E-PT20-FG-B156		E-PT20-RW-B156		E-PT20-SA-B156	E-PT20-SD-B156
30	E-PT30-FC-B72	E-PT30-FW-B72	E-PT30-FG-B72	E-PT30-RC-B72	E-PT30-RW-B72	E-PT30-RD-B72	E-PT30-SA-B72	E-PT30-SD-B72
40	E-PT40-FC-B60	E-PT40-FW-B60	E-PT40-FG-B60	E-PT50-RC-B60	E-PT40-RW-B60		E-PT40-SA-B60	E-PT40-SD-B60
50	E-PT50-FC-B36	E-PT50-FW-B36	E-PT50-FG-B36	E-PT50-RC-B36	E-PT50-RW-B36	E-PT50-RD-B36	E-PT50-SA-B36	E-PT50-SD-B36
70	E-PT70-FC-B24	E-PT70-FW-B24	E-PT70-FG-B24	E-PT70-RC-B24	E-PT70-RW-B24	E-PT70-RD-B24	E-PT70-SA-B36	E-PT70-SD-B24



PN						
						
Material	TPU	TPU	TPU	TPU	TPU+	TPU+
Hardness	85ShA	85ShA	85ShA	65ShA	87ShA	87ShA
Color	Cobalt blue	White	Green	Dark green	Cobalt blue	White
Food grade	•	•	•	•	•	•
Hydrol. Resist.					•	•
Height [mm]	Product name					
20	E-PN20-FC-B144	E-PN20-FW-B144	E-PN20-FG-B144	E-PN20-FD-B144		
30	E-PN30-FC-B100	E-PN30-FW-B100	E-PN30-FG-B100	E-PN30-FD-B100	E-PN30-HC-B100	E-PN30-HW-B100
40	E-PN40-FC-B60	E-PN40-FW-B60	E-PN40-FG-B60	E-PN40-FD-B60		
40x22				E-PN40x22-FD-C60		
60	E-PN60-FC-B43	E-PN60-FW-B43	E-PN60-FG-B43	E-PN60-FD-B43	E-PN60-HC-B43	E-PN60-HW-B43
80	E-PN80-FC-B36	E-PN80-FW-B36	E-PN80-FG-B43	E-PN80-FD-B36		

PQ							
							
Material	TPU+	TPU+	TPU	TPU	TPU	TPU	TPU
Hardness	83ShA	83ShA	85ShA	85ShA	85ShA	85ShA	85ShA
Color	Cobalt blue	White	Cobalt blue	White	Green	Dark green	White
Food grade	•	•	•	•	•	•	•
Hydrol. Resist.	•	•					
Height [mm]	Product name						
4			E-PQ04-FC-C200	E-PQ04-FW-C200			E-PQ04-FW-C200+N
				E-PQ04-FW-B540			
8	E-PQ08-GC-B300	E-PQ08-GW-B300	E-PQ08-FC-C100	E-PQ08-FW-C100	E-PQ08-FG-C100		
				E-PQ08-FW-B300	E-PQ08-FG-B300		
12	E-PQ12-GC-B150	E-PQ12-GW-B150	E-PQ12-FC-C50	E-PQ12-FW-C50	E-PQ12-FG-C50	E-PQ12-FD-B150	
			E-PQ12-FC-B150	E-PQ12-FW-B150	E-PQ12-FG-B150		
16	E-PQ16-GC-B150	E-PQ16-GW-B150		E-PQ16-FW-C50	E-PQ12-FG-B150		
				E-PQ16-FW-B150	E-PQ16-FG-B150		

PQ					
					
Material	PVC	PVC	PVC	PVC	TPO
Hardness	65ShA	65ShA	65ShA	65ShA	85ShA
Color	Cobalt blue	White	Anthracite	Dark green	White
Food grade	•	•			•
Hydrol. Resist.					•
Height [mm]	Product name				
4			E-PQ04-SA-C200		
8	E-PQ08-RC-C100	E-PQ08-RW-C100	E-PQ08-SA-C100	E-PQ08-SD-C100	E-PQ08-CW-C100
	E-PQ08-RC-B300	E-PQ08-RW-B300	E-PQ08-SA-B300	E-PQ08-SD-B300	
12	E-PQ12-RC-C50	E-PQ12-RW-C50	E-PQ12-SA-C50	E-PQ12-SD-C50	
	E-PQ12-RC-B150	E-PQ12-RW-B150	E-PQ12-SA-B150	E-PQ12-SD-B150	
16	E-PQ16-RC-B50	E-PQ16-RW-C50	E-PQ16-SA-C50	E-PQ16-SD-C50	
		E-PQ16-RW-B150	E-PQ16-SA-B150	E-PQ16-SD-B150	

PB			
			
Material	TPU	TPU	TPU
Hardness	85ShA	85ShA	85ShA
Color	Cobalt blue	White	Dark green
Food grade	•	•	•
Height [mm]	Product name		
20	E-PB20-FC-B120	E-PB20-FW-B120	E-PB20-FD-B120
30	E-PB30-FC-B84	E-PB30-FW-B84	E-PB30-FD-B84
40	E-PB40-FC-B60	E-PB40-FW-B60	E-PB40-FD-B60
50	E-PB50-FC-B48	E-PB50-FW-B48	E-PB50-FD-B48

PS	
	 
Material	TPU+
Hardness	87ShA
Color	Cobalt blue
Food grade	•
Hydrol. Resist.	•
Height [mm]	Product name
75 (3")	E-PS03-HC-B144
100 (4")	E-PS04-HC-B144
150 (6")	E-PS06-HC-B72

PI			
			
Material	PVC	PVC	PVC
Hardness	65ShA	65ShA	65ShA
Color	Cobalt blue	White	Dark green
Food grade	•	•	•
Height [mm]	Product name		
105	E-PI105-RC-B500	E-PI105-RW-B500	E-PI105-RD-B500

Tracking guides are placed on the running side of conveyor belts or on the tooth side of timing belts. This provides true belt tracking in applications where long narrow belts are used for conveying products. Tracking guides are also common where products are side loaded, which could otherwise cause a lateral shift in the belt's direction of travel. The tracking guides can be notched or deep notched to provide maximum flexibility around the pulleys.

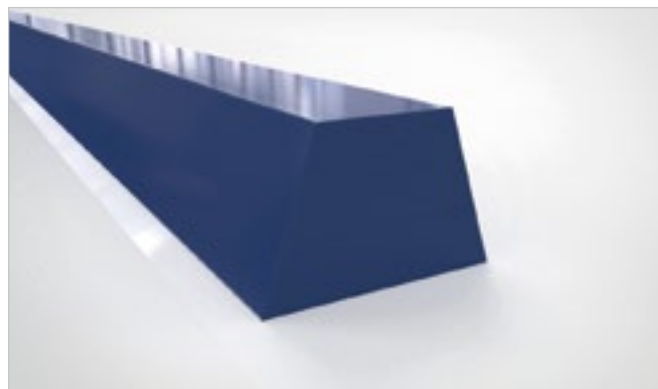

E-PV* – Standard



E-PV*+N – Notched









E-PV*+NN – Deep notched









E-PU* – Flat notched







Standard

	PV					
						
Material	TPU+	TPU+	TPU	TPU	TPU	TPU
Hardness	83ShA	83ShA	85ShA	85ShA	85ShA	65ShA
Color	Cobalt blue	White	Cobalt blue	White	Green	Transparent
Food grade	•	•	•	•	•	
Hydrol. Resist.	•	•				
Thickness [mm]	Product name					
6	E-PV06-GC-C300	E-PV06-GW-C300		E-PV06-FW-C200		E-PV06-WT-C300
8	E-PV08-GC-C200	E-PV08-GW-C200	E-PV08-FC-C200	E-PV08-FW-C200		E-PV08-WT-C200
10	E-PV10-GC-C200	E-PV10-GW-C200	E-PV10-FC-C200	E-PV10-FW-C200	E-PV10-FG-C200	E-PV10-WT-C200
13	E-PV13-GC-C100	E-PV13-GW-C100	E-PV13-FC-C100	E-PV13-FW-C100	E-PV13-FG-C100	E-PV13-WT-C100
17				E-PV17-FW-C50	E-PV17-FG-C50	E-PV17-WT-C50

Notched

PV+N							
							
Material	TPU+	TPU+	TPU	TPU	TPU	TPU	TPU
Hardness	83ShA	83ShA	85ShA	85ShA	65ShA	65ShA	92ShA
Color	Cobalt blue	White	White	Green	Natural	Transparent	White
Food grade	•	•	•	•			
Hydrol. Resist.	•	•					
B [mm]	Product name						
6	E-PV06-GC-C300+N	E-PV06-GW-C300+N			E-PV06-WN-C300+N		
8			E-PV08-FW-C200+N				
10			E-PV10-FW-C200+N	E-PV10-FG-C200+N		E-PV10-WT-C200+N	
13			E-PV13-FW-C100+N	E-PV13-FG-C100+N		E-PV13-WT-C100+N	
17			E-PV17-FW-C50+N	E-PV17-FG-C50+N		E-PV17-WT-C50+N	E-PV17-TW-C50+N





Deep notched





PV+NN						
						
Material	TPU+	TPU+	TPU	TPU	TPU	TPU
Hardness	83ShA	83ShA	85ShA	85ShA	85ShA	65ShA
Color	Cobalt blue	White	Cobalt blue	White	Green	Transparent
Food grade	•	•	•	•	•	
Hydrol. Resist.	•	•				
B [mm]	Product name					
06						E-PV06-TW-C300+NN
08	E-PV08-GC-C200+NN	E-PV08-GW-C200+NN	E-PV08-FC-C200+NN	E-PV08-FW-C200+NN		
10	E-PV10-GC-C200+NN	E-PV10-GW-C200+NN	E-PV10-FC-C200+NN	E-PV10-FW-C200+NN		E-PV10-TW-C200+NN
13	E-PV13-GC-C100+NN	E-PV13-GW-C100+NN	E-PV13-FC-C100+NN	E-PV13-FW-C100+NN		E-PV13-TW-C100+NN
17				E-PV17-FW-C50+NN	E-PV17-FG-C50+NN	

Flat notched





PU	
	
Material	TPU
Hardness	85ShA
Color	White
Food grade	•
B [mm]	Product name
15	E-PU15-FW-C50
25	E-PU25-FW-C50

PVC tracking guides Standard

PV				
				
Material	PVC	PVC	PVC	PVC
Hardness	65ShA	65ShA	65ShA	55ShA
Color	Cobalt blue	White	Dark green	Anthracite
Food grade	•	•	•	
B [mm]	Product name			
06	E-PV06-RC-C300	E-PV06-RW-C300	E-PV06-RD-C300	
08	E-PV08-RC-C200	E-PV08-RW-C200	E-PV08-RD-C200	
10	E-PV10-RC-C200	E-PV10-RW-C200	E-PV10-RD-C200	E-PV10-OA-C200
13	E-PV13-RC-C100	E-PV13-RW-C100	E-PV13-RD-C100	E-PV13-OA-C100
22				







PV				
				
Material	PVC	PVC	PVC	PVC
Hardness	65ShA	65ShA	55ShA	55ShA
Color	Anthracite	Dark green	White	White
Food grade			•	•
Hydrol. Resist.			•	•
B [mm]	Product name			
06	E-PV06-SA-C300	E-PV06-SD-C300	E-PV06-EW-C200	
08	E-PV08-SA-C200	E-PV08-SD-C200	E-PV08-EW-C200	
10	E-PV10-SA-C200	E-PV10-SD-C200	E-PV10-EW-C200	
13	E-PV13-SA-C100	E-PV13-SD-C100	E-PV13-EW-C100	E-PV13-CW-C100
22	E-PV22-SA-C50			

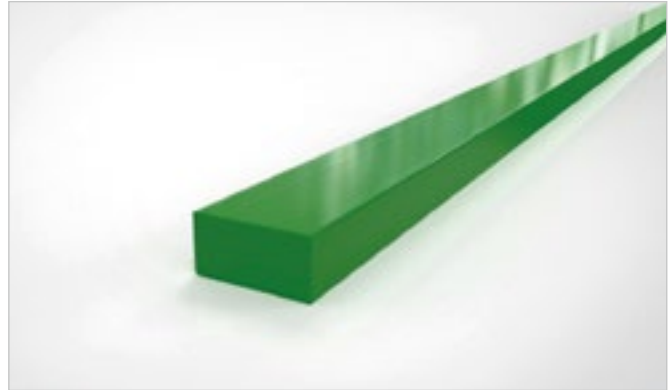





Notched

PV+N				
				
Material	PVC	PVC	PVC	PVC
Hardness	65ShA	55ShA	65ShA	65ShA
Color	White	Anthracite	Anthracite	Dark green
Food grade	•			
B [mm]	Product name			
6	E-PV06-RW-C300+N		E-PV06-SA-C300+N	
8	E-PV08-RW-C200+N		E-PV08-SA-C200+N	E-PV08-SD-C200+N
10	E-PV10-RW-C200+N	E-PV10-OA-C200+N	E-PV10-SA-C200+N	E-PV10-SD-C200+N
13	E-PV13-RW-C100+N	E-PV13-OA-C100+N	E-PV13-SA-C100+N	E-PV13-SD-C100+N
17	E-PV17-RW-C50+N	E-PV17-OA-C50+N	E-PV17-SA-C50+N	E-PV17-SD-C50+N
22			E-PV22-SA-C50+N	
30		E-PV30-OA-C25+N	E-PV30-SA-C25+N	

Habasit can edge seal TPU-, TPO- and PVC-coated conveyor belts. Edge sealing is an additional hygiene measure mostly found in food applications to protect the inner layer of coated fabric belts from soiling by liquids or contamination by microorganisms. Edge sealing can also be applied to avoid fiber contamination of products, machines or bearings.









PE							
							
Material	TPU+	TPU+	TPU	TPU	TPU	TPU	TPU
Hardness	83ShA	83ShA	85ShA	85ShA	85ShA	95ShA	95ShA
Color	Cobalt blue	White	White	Green	Transparent	Cobalt blue	Green
Food grade	•	•	•	•	•	•	•
Hydrol. Resist.	•	•					
B [mm]	Product name						
14	E-PE14-GC-C100	E-PE14-GW-C100	E-PE14-FW-C100	E-PE14-FG-C100	E-PE14-FT-C100	E-PE14-YC-C100	E-PE14-YG-C100

PE							
							
Material	PVC	PVC	PVC	PVC	TPO	TPO	TPO
Hardness	65ShA	65ShA	65ShA	65ShA	85ShA	85ShA	85ShA
Color	Cobalt blue	White	Dark green	Anthracite	Cobalt blue	Natural	White
Food grade	•	•	•		•	•	•
Hydrol. Resist.					•	•	•
B [mm]	Product name						
14	E-PE14-RC-C100	E-PE14-RW-C100	E-PE14-RD-C100	E-PE14-SA-C100	E-PE14-CC-C100	E-PE14-CN-C100	E-PE14-CW-C100

Habasit Habibord flexible and wear resistant corrugated sidewall profiles can be applied on TPU conveyors and processing belts. Profiles are applied to the conveying side of a belt using a high-frequency welding process. Habibord can be used in a wide range of applications in order to contain bulk goods at the sides of conveyor belts. Pre-formed flat profiles can be cut down in height; the excellent flexibility of the polyurethane permits small pulley diameters.



	PL					
						
Material	TPU+	TPU+	TPU	TPU	TPU	TPU
Hardness	87ShA	87ShA	85ShA	85ShA	85ShA	85ShA
Color	Cobalt blue	White	Cobalt blue	White	Green	Dark green
Food grade	•	•	•	•	•	•
Hydrol. Resist.	•	•				
Thickness [mm]	Product name					
1.3	E-PL13-HC-B40	E-PL13-HW-B40	E-PL13-FC-B40	E-PL13-FW-B40	E-PL13-FG-B40	E-PL13-FD-B40

Habicord (Standard TPU round belts)

Diameter [mm]	Material	Hardness [SHA]	Color	Package type	Package quantity	Order code	Product name	Description	Specific weight [kg/m]	C.O.F. on steel	k8% static	k8% relaxed	Peripheral force [N]
02	TPU	87	Green	Coil	600	H090031303	E-RB02-KG-C600 HABCORD	HABCORD R-2	0.00	0.4	8	6	10
03	TPU	87	Green	Coil	300	H090031306	E-RB03-KG-C300 HABCORD	HABCORD R-3	0.01	0.4	18	13	23
04	TPU	87	Green	Coil	250	H090031309	E-RB04-KG-C250 HABCORD	HABCORD R-4	0.01	0.4	32	23	41
05	TPU	87	Green	Coil	250	H090031312	E-RB05-KG-C250 HABCORD	HABCORD R-5	0.02	0.4	49	36	65
06	TPU	87	Green	Coil	250	H090031315	E-RB06-KG-C250 HABCORD	HABCORD R-6	0.03	0.4	71	52	93
07	TPU	87	Green	Coil	200	H090031318	E-RB07-KG-C200 HABCORD	HABCORD R-7	0.04	0.4	97	71	127
08	TPU	87	Green	Coil	200	H090031321	E-RB08-KG-C200 HABCORD	HABCORD R-8	0.06	0.4	126	92	165
10	TPU	87	Green	Coil	100	H090031327	E-RB10-KG-C100 HABCORD	HABCORD R-10	0.09	0.4	197	145	258
12	TPU	87	Green	Coil	100	H090031333	E-RB12-KG-C100 HABCORD	HABCORD R-12	0.13	0.4	284	208	372
15	TPU	87	Green	Coil	50	H090031342	E-RB15-KG-C50 HABCORD	HABCORD R-15	0.20	0.4	444	325	582
18	TPU	87	Green	Coil	50	H090031343	E-RB18-KG-C50 HABCORD	HABCORD R-18	0.30	0.4	635	464	845
20	TPU	87	Green	Coil	50	H090031357	E-RB20-KG-C50 HABCORD	HABCORD R-20/7	0.37	0.4	784	572	1045
Rough Habicord													
02	TPU	87	Green	Coil	600	S090031364	E-RB02-KG-C600+R HABCORD	HABCORD R-2R	0.00	0.4	8	6	10
03	TPU	87	Green	Coil	300	H090031359	E-RB03-KG-C300+R HABCORD	HABCORD R-3R	0.01	0.4	18	13	23
04	TPU	87	Green	Coil	250	H090031358	E-RB04-KG-C250+R HABCORD	HABCORD R-4R	0.01	0.4	32	23	41
05	TPU	87	Green	Coil	250	H090031360	E-RB05-KG-C250+R HABCORD	HABCORD R-5R	0.02	0.4	49	36	65
06	TPU	87	Green	Coil	250	H090031361	E-RB06-KG-C250+R HABCORD	HABCORD R-6R	0.03	0.4	71	52	93
08	TPU	87	Green	Coil	200	H090031363	E-RB08-KG-C200+R HABCORD	HABCORD R-8R	0.06	0.4	126	92	165
12	TPU	87	Green	Coil	100	S090031365	E-RB12-KG-C100+R HABCORD	HABCORD R-12R	0.13	0.4	284	208	372
15	TPU	87	Green	Coil	50	H090031366	E-RB15-KG-C50+R HABCORD	HABCORD R-15R	0.20	0.4	444	325	582
Smooth Habicord													
05	TPU	87	Green	Coil	250	H090031367	E-RB05-KG-C250+S HABCORD	HABCORD R-5B	0.02	0.4	49	36	65
06	TPU	87	Green	Coil	250	H090031372	E-RB06-KG-C250+S HABCORD	HABCORD R-6B	0.03	0.4	71	52	93
08	TPU	87	Green	Coil	200	H090031368	E-RB08-KG-C200+S HABCORD	HABCORD R-8B	0.06	0.4	126	92	165
10	TPU	87	Green	Coil	100	H090031370	E-RB10-KG-C100+S HABCORD	HABCORD R-10B	0.09	0.4	197	145	258
12	TPU	87	Green	Coil	100	H090031371	E-RB12-KG-C100+S HABCORD	HABCORD R-12B	0.13	0.4	284	208	372
1/4	TPU	87	Green	Coil	250	S090031367	E-RB1/4-KG-C250+S HABCORD	HABCORD R-6,3B	x	x	x	x	x
Reinforced Habicord													
04	TPU	87	Cobalt blue	Coil	250	S090033674	E-RR04-KC-C250 HABCORD	HABCORD RR-4	x	x	x	x	x
06	TPU	87	Cobalt blue	Coil	250	S090033676	E-RR06-KC-C250 HABCORD	HABCORD RR-6	x	x	x	x	x
10	TPU	87	Cobalt blue	Coil	100	H090033681	E-RR10-KC-C100 HABCORD	HABCORD RR-10	0.09	0.75	x	x	x
12	TPU	87	Cobalt blue	Coil	100	S090033683	E-RR12-KC-C100 HABCORD	HABCORD RR-12	0.13	0.75	x	x	x
1/2	TPU	87	Cobalt blue	Coil	100	S090033682	E-RR1/2-KC-C100 HABCORD	HABCORD RR-12,5	x	x	x	x	x

x Data available on request

Polycord® (High quality TPU round belts)

Diameter [mm]	Material	Hardness [SHA]	Color	Package type	Package quantity	Order code	Product name	Description	Specific weight [kg/m]	C.O.F. on steel	k8% static	k8% relaxed	Peripheral force [N]
02	TPU	87	Green	Coil	600	H010100193	E-RB02-KG POLYCORD	POLYCORD R-2	0.00	0.4	8	6	10
03	TPU	87	Green	Coil	300	H010100231	E-RB03-KG POLYCORD	POLYCORD R-3	0.01	0.4	18	13	23
04	TPU	87	Green	Coil	250	H010100156	E-RB04-KG POLYCORD	POLYCORD R-4	0.02	0.4	32	23	41
05	TPU	87	Green	Coil	250	H010100191	E-RB05-KG POLYCORD	POLYCORD R-5	0.02	0.4	51	36	65
06	TPU	87	Green	Coil	250	H010100324	E-RB06-KG POLYCORD	POLYCORD R-6	0.03	0.4	73	52	93
07	TPU	87	Green	Coil	200	H010100431	E-RB07-KG POLYCORD	POLYCORD R-7	0.05	0.4	99	71	127
08	TPU	87	Green	Coil	200	H010100432	E-RB08-KG POLYCORD	POLYCORD R-8	0.06	0.4	129	92	165
10	TPU	87	Green	Coil	100	H010100268	E-RB10-KG POLYCORD	POLYCORD R-10	0.09	0.4	202	145	258
12	TPU	87	Green	Coil	100	H010100460	E-RB12-KG POLYCORD	POLYCORD R-12	0.14	0.4	291	208	372
15	TPU	87	Green	Coil	50	H010100172	E-RB15-KG POLYCORD	POLYCORD R-15	0.21	0.4	455	325	582

Habibblue (Hydrolysis resistant round belts)

Diameter [mm]	Material	Food grade	Hardness [SHA]	Color	Package type	Package quantity	Order code	Product name	Description	Specific weight [kg/m]	C.O.F. on steel	k8% static	k8% relaxed	Peripheral force [N]
3	TPU+	●	87	Cobalt blue	Coil	300	H090031186	E-RB03-HC-C300 HABIBLUE	HABIBLUE R-3	0.01	0.4	13	8	15
4	TPU+	●	87	Cobalt blue	Coil	250	H090031187	E-RB04-HC-C250 HABIBLUE	HABIBLUE R-4	0.01	0.4	23	15	27
5	TPU+	●	87	Cobalt blue	Coil	250	H090031185	E-RB05-HC-C250 HABIBLUE	HABIBLUE R-5	0.02	0.4	35	24	42
6	TPU+	●	87	Cobalt blue	Coil	250	H090031188	E-RB06-HC-C250 HABIBLUE	HABIBLUE R-6	0.03	0.4	51	34	61
8	TPU+	●	87	Cobalt blue	Coil	200	H090031189	E-RB08-HC-C200 HABIBLUE	HABIBLUE R-8	0.06	0.4	90	61	109
10	TPU+	●	87	Cobalt blue	Coil	100	H090031190	E-RB10-HC-C100 HABIBLUE	HABIBLUE R-10	0.09	0.4	141	95	170
12	TPU+	●	87	Cobalt blue	Coil	100	H090031191	E-RB12-HC-C100 HABIBLUE	HABIBLUE R-12	0.12	0.4	203	137	244

Polywhite (Food grade round belts)

Diameter [mm]	Material	Food grade	Hardness [SHA]	Color	Package type	Package quantity	Order code	Product name	Description	Specific weight [kg/m]	C.O.F. on steel	k8% static	k8% relaxed	Peripheral force [N]
3	TPU	●	85	White	Coil	300	H090031143	E-RB03-FW-C300 POLYWHITE	POLYWHITE R-3 FW	0.01	0.4	13	8	15
4	TPU	●	85	White	Coil	250	H090031144	E-RB04-FW-C250 POLYWHITE	POLYWHITE R-4 FW	0.02	0.4	22	15	27
5	TPU	●	85	White	Coil	250	H090031145	E-RB05-FW-C250 POLYWHITE	POLYWHITE R-5 FW	0.03	0.4	37	24	42
6	TPU	●	85	White	Coil	250	H090031146	E-RB06-FW-C250 POLYWHITE	POLYWHITE R-6 FW	0.04	0.4	52	34	61
7	TPU	●	85	White	Coil	200	H090031147	E-RB07-FW-C200 POLYWHITE	POLYWHITE R-7 FW	0.05	0.4	70	46	83
8	TPU	●	85	White	Coil	200	H090031148	E-RB08-FW-C200 POLYWHITE	POLYWHITE R-8 FW	0.06	0.4	93	61	109
10	TPU	●	85	White	Coil	100	H090031149	E-RB10-FW-C100 POLYWHITE	POLYWHITE R-10 FW	0.09	0.4	143	95	170
12	TPU	●	85	White	Coil	100	H090031150	E-RB12-FW-C100 POLYWHITE	POLYWHITE R-12 FW	0.1	0.4	206	137	244
15	TPU	●	85	White	Coil	50	H090031151	E-RB15-FW-C50 POLYWHITE	POLYWHITE R-15 FW	0.21	0.4	322	213	382

Habiring (Endless round belts)

Diameter [mm]	Material	Hardness [SHA]	Color	Package type	Package quantity	Order code	Product name	Description
2.0x118	TPU	87	Green	Box	1000	S090031650	M-RB2.0x118-KG-B1000 HABIRING	HABIRING R-2.0 X152
2.0x128	TPU	87	Green	Box	1000	S090031651	M-RB2.0x128-KG-B1000 HABIRING	HABIRING R-2.0 X153
2.0x147	TPU	87	Green	Box	1000	S090031610	M-RB2.0x147-KG-B1000 HABIRING	HABIRING R-2.0 X147
2.5x078	TPU	87	Cobalt blue	Box	1000	S090031615	M-RB2.5x078-KC-B1000 HABIRING	HABIRING R-2.0 X148
2.5x078	TPU	87	Green	Box	1000	S090031652	M-RB2.5x078-KG-B1000 HABIRING	HABIRING R-2.0 X154
2.5x078	TPU	87	Yellow	Box	1000	S090031665	M-RB2.5x078-KY-B1000 HABIRING	HABIRING R-2.0 X161
2.7x268	TPU	87	Cobalt blue	Box	1000	S090031616	M-RB2.7x268-KC-B1000 HABIRING	HABIRING R-2.0 X149
2.7x268	TPU	87	Yellow	Box	1000	S090031663	M-RB2.7x268-KY-B1000 HABIRING	HABIRING R-2.0 X159
2.7x307	TPU	87	Cobalt blue	Box	1000	S090031617	M-RB2.7x307-KC-B1000 HABIRING	HABIRING R-2.0 X150
2.7x307	TPU	87	Yellow	Box	1000	S090031664	M-RB2.7x307-KY-B1000 HABIRING	HABIRING R-2.0 X160
3.0x140	TPU	87	Green	Box	1000	S090031654	M-RB3.0x140-KG-B1000 HABIRING	HABIRING R-2.0 X155
3.0x155	TPU	87	Green	Box	1000	S090031658	M-RB3.0x155-KG-B1000 HABIRING	HABIRING R-2.0 X157
3.0x175	TPU	87	Green	Box	1000	S090031657	M-RB3.0x175-KG-B1000 HABIRING	HABIRING R-2.0 X156
3.0x175	TPU	87	Natural	Box	1000	S090031950	M-RB3.0x175-KN-B1000 HABIRING	HABIRING R-2.0 X180
3.0x245	TPU	87	Green	Box	1000	S090031662	M-RB3.0x245-KG-B1000 HABIRING	HABIRING R-2.0 X158
3.2x133	TPU	87	Green	Box	1000	S090031688	M-RB3.2x133-KG-B1000 HABIRING	HABIRING R-2.0 X162
3.5x207	TPU	87	Natural	Box	1000	S090031690	M-RB3.5x207-KN-B1000 HABIRING	HABIRING R-2.0 X163
4.0x112	TPU	87	Green	Box	1000	S090031705	M-RB4.0x112-KG-B1000 HABIRING	HABIRING R-2.0 X164
4.0x122	TPU	87	Green	Box	1000	S090031710	M-RB4.0x122-KG-B1000 HABIRING	HABIRING R-2.0 X165
4.0x258	TPU	87	Cobalt blue	Box	1000	S090031618	M-RB4.0x258-KC-B1000 HABIRING	HABIRING R-2.0 X151
5.0x123	TPU	87	Green	Box	1000	S090031761	M-RB5.0x123-KG-B1000 HABIRING	HABIRING R-2.0 X167
5.0x182	TPU	87	Green	Box	1000	S090031763	M-RB5.0x182-KG-B1000 HABIRING	HABIRING R-2.0 X168
5.0x196	TPU	87	Green	Box	1000	S090031760	M-RB5.0x196-KG-B1000 HABIRING	HABIRING R-2.0 X166
6.0x095	TPU	87	Green	Box	1000	S090031810	M-RB6.0x095-KG-B1000 HABIRING	HABIRING R-2.0 X169
6.0x119	TPU	87	Green	Box	1000	S090031811	M-RB6.0x119-KG-B1000 HABIRING	HABIRING R-2.0 X170
6.0x130	TPU	87	Green	Box	1000	S090031812	M-RB6.0x130-KG-B1000 HABIRING	HABIRING R-2.0 X171
6.0x142	TPU	87	Green	Box	1000	S090031813	M-RB6.0x142-KG-B1000 HABIRING	HABIRING R-2.0 X172
6.0x200	TPU	87	Green	Box	1000	S090031814	M-RB6.0x200-KG-B1000 HABIRING	HABIRING R-2.0 X173
6.5x445	TPU	87	Green	Box	1000	S090031930	M-RB6.5x445-KG-B1000 HABIRING	HABIRING R-2.0 X179
7.0x119	TPU	87	Green	Box	1000	S090031853	M-RB7.0x119-KG-B1000 HABIRING	HABIRING R-2.0 X174
7.0x128	TPU	87	Green	Box	1000	S090031860	M-RB7.0x128-KG-B1000 HABIRING	HABIRING R-2.0 X175
7.0x130	TPU	87	Green	Box	1000	S090031861	M-RB7.0x130-KG-B1000 HABIRING	HABIRING R-2.0 X176
7.0x170	TPU	87	Green	Box	1000	S090031863	M-RB7.0x170-KG-B1000 HABIRING	HABIRING R-2.0 X178
7.0x173	TPU	87	Green	Box	1000	S090031862	M-RB7.0x173-KG-B1000 HABIRING	HABIRING R-2.0 X177

Habipur

Width [mm]	Material	Hardness [SHA]	Color	Package type	Package quantity	Order code	Product name	Description	Specific weight [kg/m]	Peripheral force [N]	Minimum pulley Ø [mm]
10	TPU	87	Green	Coil	200	H090033110	E-VT10-KG-C200 HABIPUR	HABIPUR V-10UXG-85	0.06	40	55
13	TPU	87	Green	Coil	100	H090033113	E-VT13-KG-C100 HABIPUR	HABIPUR V-13UXG-85	0.1	70	65
13	TPU	87	Red	Coil	100	S090033114	E-VT13-KR-C100 HABIPUR	HABIPUR V-13 UXR 85	0.1	70	65
17	TPU	87	Green	Coil	50	H090033117	E-VT17-KG-C50 HABIPUR	HABIPUR V-17UXG-85	0.17	130	80
17	TPU	87	Red	Coil	50	S090033118	E-VT17-KR-C50 HABIPUR	HABIPUR V-17UXR-85	0.17	130	80
22	TPU	87	Green	Coil	50	H090033122	E-VT22-KG-C50 HABIPUR	HABIPUR V-22UXG-85	0.28	240	130
Grip top											
10	TPU	87	Green	Coil	50	H090033410	E-VT10-KG-C50+G HABIPUR	HABIPUR V-10UGG-85	0.09	40	65
13	TPU	87	Green	Coil	50	H090033413	E-VT13-KG-C50+G HABIPUR	HABIPUR V-13UGG-85	0.14	50	75
17	TPU	87	Green	Coil	50	H090033417	E-VT17-KG-C50+G HABIPUR	HABIPUR V-17UGG-85	0.24	120	87
22	TPU	87	Green	Coil	50	H090033422	E-VT22-KG-C50+G HABIPUR	HABIPUR V-22UGG-85	0.36	160	130
Reinforced											
13	TPU	87	Cobalt blue	Coil	100	H090033613	E-VR13-KC-C100 HABIPUR	HABIPUR VR-13UXS-85	0.1	230	75
17	TPU	87	Cobalt blue	Coil	50	H090033617	E-VR17-KC-C50 HABIPUR	HABIPUR VR-17UXS-85	0.18	320	100
17	TPU	87	Red	Coil	50	S090033619	E-VR17-KR-C50 HABIPUR	HABIPUR VR-17UXR-85	0.18	320	100
22	TPU	87	Cobalt blue	Coil	50	H090033622	E-VR22-KC-C50 HABIPUR	HABIPUR VR-22UXS-85	0.28	410	130
Reinforced + grip top											
13	TPU	87	Cobalt blue	Coil	50	H090033631	E-VR13-KC-C50+G HABIPUR	HABIPUR VR-13UGS-85	0.15	180	60
17	TPU	87	Cobalt blue	Coil	50	H090033632	E-VR17-KC-C50+G HABIPUR	HABIPUR VR-17UGS-85	0.24	230	80
22	TPU	87	Cobalt blue	Coil	50	S090033633	E-VR22-KC-C50+G HABIPUR	VR-22 UGS 85	×	×	×

Crested Habipur

Width [mm]	Material	Hardness [SHA]	Color	Package type	Package quantity	Order code	Product name	Description	Specific weight [kg/m]	Peripheral force [N]	Minimum pulley Ø [mm]
17	TPU	87	Green	Coil	100	H090033317	E-VC17-KG-C100 HABIPUR	HABIPUR V-17UCG-85	0.28	340	175
22	TPU	87	Green	Coil	30	H090033322	E-VC22-KG-C30 HABIPUR	HABIPUR V-22UCG-85	0.45	410	225
Reinforced											
17	TPU	87	Cobalt blue	Coil	50	H090033647	E-VS17-KC-C50 HABIPUR	HABIPUR VR-17UCS-85	0.28	320	160
22	TPU	87	Cobalt blue	Coil	50	H090033652	E-VS22-KC-C50 HABIPUR	HABIPUR VR-22UCS-85	0.42	450	180

Raised Habipur

Width [mm]	Material	Hardness [SHA]	Color	Package type	Package quantity	Order code	Product name	Description	Specific weight [kg/m]	Peripheral force [N]	Minimum pulley Ø [mm]
10	TPU	87	Green	Coil	100	H090033210	E-VU10-KG-C100 HABIPUR	HABIPUR V-10URG-85	0.09	60	70
13	TPU	87	Green	Coil	100	H090033213	E-VU13-KG-C100 HABIPUR	HABIPUR V-13URG-85	0.12	70	80
17	TPU	87	Green	Coil	50	H090033217	E-VU17-KG-C50 HABIPUR	HABIPUR V-17URG-85	0.22	150	90

× Data available on request

T-shape belts

Width [mm]	Material	Food grade	Hardness [SHA]	Color	Package type	Package quantity	Order code	Product name	Description	Specific weight [kg/m]	Peripheral force [N]	Minimum pulley Ø [mm]
12	TPU+	●	83	White	Coil	200	H090035619	E-TT12-GW-C200	T-12x5HXW	0.6	12.7	40
	TPU+	●	83	Cobalt blue	Coil	200	H090035620	E-TT12-GC-C200	T-12x5HXC	0.6	12.7	40
	TPU		85	White	Coil	50	S090035608	E-TT12-KW-C50 HABIPUR	T-12x5UXW	×	×	×
25	TPU		85	White	Coil	50	S090035604	E-TT25-KW-C50 HABIPUR	T-25x5UXW	×	×	×
	TPU		85	Green	Coil	200	S090035605	E-TT25-KG-C200 HABIPUR	T-25x5UXG	×	×	×
	TPU+	●	87	Cobalt blue	Coil	100	H090035601	E-TT25-HC-C100 HABIBLUE	T-25x5HXC	0.8	12.7	40
	TPU+	●	87	White	Coil	100	H090035618	E-TT25-HW-C100 HABIBLUE	T-25x5HXW	0.8	12.7	40
28	TPU+	●	87	Cobalt blue	Coil	100	H090035617	E-TT28-HC-C100 HABIBLUE	TT-28x5HXC	0.09	11.7	50

Flat belts

Thickness [mm]	Material	Food grade	Hardness [SHA]	Color	Package type	Package quantity	Order code	Product name	Description	Specific weight [kg/m]	Top surface	Bottom surface
1.3	TPU+	●	87	Cobalt blue	Coil	100	H090060057	E-FB13-HC-C100	FLAT PQH-250/1.35XC85	0.5	Smooth	Smooth
	TPU+	●	87	White	Coil	100	H090060056	E-FB13-HW-C100	FLAT PQH-250/1.35XW85	0.5		
	TPU		65	Transparent	Coil	100	H090060139	E-FB13-WT-C100	FLAT PQF-250/2.00XT60	0.5		
	TPU	●	85	Cobalt blue	Coil	100	S090060046	E-FB13-FC-C100	FLAT PQF-250/1.35XC85	0.5		
	TPU	●	85	Dark green	Coil	100	S090060042	E-FB13-FD-C100	FLAT PQF-250/1.35XD85	0.5		
	TPU	●	85	White	Coil	100	S090060041	E-FB13-FW-C100	FLAT PQF-250/1.35XW85	0.5		
	TPU	●	85	Green	Coil	100	S090060040	E-FB13-FG-C100	FLAT PQF-250/1.35XG85	0.5		
1.6	TPU		65	Transparent	Coil	100	H090060082	E-FB16-WT-C100	FLAT PQF-250/1.60XT60	0.6		
1.7	TPU	●	85	White	Coil	100	H090060096	E-FB17-FW-C100	FLAT PQF-250/1.70XW85	0.6		
2	TPU		65	Transparent	Coil	100	H090060083	E-FB20-WT-C100	FLAT PQF-250/2.00XT60	0.67		
	TPU	●	85	Yellow	Coil	100	S090031380	E-FB20-FY-C100	FLAT PQF-250/2.00XY85	0.67		
	TPU	●	85	Transparent	Coil	100	H090060134	E-FB20-FT-C100	FLAT PQF-250/2.00XT85	0.67		
	TPU	●	85	Cobalt blue	Coil	100	H090060079	E-FB20-FC-C100	FLAT PQF-250/2.00XC85	0.67		
	TPU	●	85	White	Coil	100	H090060047	E-FB20-FW-C100	FLAT PQF-250/2.00XW85	0.67		
	TPU		92	Natural	Coil	100	H090060087	E-FB20-TN-C100	FLAT PQF-250/2.00XN92	0.67		
	TPEE	●	55	Red	Coil	100	H090060104	E-FB20-ER-C100	FLAT PQE-250/2.00XR55	0.67		
2.2	TPU+	●	87	Cobalt blue	Coil	100	H090060100	E-FB22-HC-C100	FLAT PQH-250/2.20XC85	×		
	TPU+	●	87	White	Coil	100	H090060099	E-FB22-HW-C100	FLAT PQH-250/2.20XW85	×		
3	TPU		65	Transparent	Coil	50	H090060084	E-FB30-WT-C50	FLAT PQF-250/3.00XT60	0.96		
	TPU	●	85	Transparent	Coil	50	H090060102	E-FB30-FT-C50	FLAT PQF-250/3.00XT85	0.96		
	TPU	●	85	White	Coil	50	H090060097	E-FB30-FW-C50	FLAT PQF-250/3.00XW85	0.96		
	TPU	●	85	Cobalt blue	Coil	50	H090060080	E-FB30-FC-C50	FLAT PQF-250/3.00XC85	0.96		
	TPU		92	Natural	Coil	50	H090060088	E-FB30-TN-C50	FLAT PQF-250/3.00XN92	0.96		
	TPEE	●	55	Red	Coil	50	H090060105	E-FB30-ER-C50	FLAT PQF-250/3.00XR55	0.96		
	PVC		65	Anthracite	Coil	50	H090034902	E-FB30-SA-C50	FLAT PRS-250/3.00XA65	0.23		

× Data available on request

Flat belts cont.

Thickness [mm]	Material	Food grade	Hardness [SHA]	Color	Package type	Package quantity	Order code	Product name	Description	Specific weight [kg/m]	Top surface	Bottom surface
4	TPU		65	Transparent	Coil	50	H090060085	E-FB40-WT-C50	FLAT PQF-250/4.00XT60	1.25		
	TPU	●	85	Dark green	Coil	50	H090060129	E-FB40-FD-C50	FLAT PQF-250/4.00XD85	1.25		
	TPU	●	85	White	Coil	50	H090060048	E-FB40-FW-C50	FLAT PQF-250/4.00XW85	1.25		
	TPU		92	Natural	Coil	50	H090060089	E-FB40-TN-C50	FLAT PQF-250/4.00XN92	1.25		
	PVC	●	65	Cobalt blue	Coil	50	H090060127	E-FB40-RC-C50	FLAT PQV-250/4.00XC65	0.55		
	PVC	●	65	Dark green	Coil	50	H090060126	E-FB40-RD-C50	FLAT PQV-250/4.00XD65	0.55		
	PVC	●	65	White	Coil	50	H090060091	E-FB40-RW-C50	FLAT PQV-250/4.00XW65	0.55		
5	TPU+	●	87	Cobalt blue	Coil	25	H090060060	E-FB50-HC-C25	FLAT PQH-250/5.00XC85	×	Smooth	Smooth
	TPU+	●	87	White	Coil	50	H090060059	E-FB50-HW-C50	FLAT PQH-250/5.00XW85	×		
	TPU		65	Transparent	Coil	25	H090060086	E-FB50-WT-C25	FLAT PQF-250/5.00XT60	1.53		
	TPU	●	85	White	Coil	50	H090060128	E-FB50-FW-C50	FLAT PQF-250/5.00XW85 (Coil 50M)	1.53		
	TPU	●	85	Cobalt blue	Coil	25	H090060098	E-FB50-FC-C25	FLAT PQF-250/5.00XC85	1.53		
	TPU	●	85	White	Coil	25	H090060049	E-FB50-FW-C25	FLAT PQF-250/5.00XW85	1.53		
	TPU		92	Natural	Coil	25	H090060090	E-FB50-TN-C25	FLAT PQF-250/5.00XN92	1.66		
	TPU	●	95	Cobalt blue	Coil	25	H090060131	E-FB50-YC-C25	FLAT PQF-250/5.00XC95	×		
Embossing impression covers												
2	TPU	●	85	Cobalt blue	Coil	100	H090037286	E-FB20-FC-C100+E(EH/T)	FLAT PQF-250/2.00XC85 EH/T	0.62	Extra Fine	Honeycomb
	TPU		65	Red	Coil	100	H090060130	E-FB20-WR-C100+E(S/H)	FLAT PQF-250/2.00XR60 S/H	0.62	Smooth	Fine
	TPU	●	85	Cobalt blue	Coil	100	H090060042	E-FB20-FC-C100+E(S/H)	FLAT PQF-250/2.00XC85 S/H	0.62	Smooth	Fine
	TPU	●	85	Cobalt blue	Coil	100	H090060041	E-FB20-FC-C100+E(S/HT)	FLAT PQF-250/2.00XC85 S/HT	0.62	Smooth	Cone Top
	TPU		85	Green	Coil	100	S090039009	E-FB20-KG-C100+E(S/LG)	FLAT PQF-250/2.00XG85 S/LG	0.62	Smooth	Long. Grooves
	TPU	●	85	Cobalt blue	Coil	100	H090060043	E-FB20-FC-C100+E(S/T)	FLAT PQF-250/2.00XC85 S/T	0.62	Smooth	Honeycomb

× Data available on request

PT

Height [mm]	Material	Food grade	Hardness [SHA]	Color	Package type	Package quantity	Order code	Product name	Description	Specific weight [kg/m]	B [mm]	H [mm]	Minimum pulley Ø [mm]
20	TPU	●	85	Cobalt blue	Box	156	H090060144	E-PT20-FC-B156	PTF-20C	0.17	20	20	80
	TPU	●	85	Green	Box	156	H090035260	E-PT20-FG-B156	PTF-20G	0.17	20	20	80
	TPU	●	85	White	Box	156	H090035160	E-PT20-FW-B156	PTF-20W	0.17	20	20	80
	PVC	●	65	White	Box	156	H090060070	E-PT20-RW-B156	PTR-20W	0.17	20	20	90
	PVC		65	Dark green	Box	156	H090034760	E-PT20-SD-B156	PTS-20D	0.17	20	20	90
	PVC		65	Anthracite	Box	156	H090034160	E-PT20-SA-B156	PTS-20A	0.17	20	20	90
30	TPU	●	85	Cobalt blue	Box	72	H090060145	E-PT30-FC-B72	PTF-30C	0.37	30	30	90
	TPU	●	85	Green	Box	72	H090035263	E-PT30-FG-B72	PTF-30G	0.37	30	30	90
	TPU	●	85	White	Box	72	H090035163	E-PT30-FW-B72	PTF-30W	0.37	30	30	90
	PVC	●	65	Dark green	Box	72	H090060108	E-PT30-RD-B72	PTR-30D	0.37	30	30	100
	PVC	●	65	White	Box	72	H090060071	E-PT30-RW-B72	PTR-30W	0.37	30	30	100
	PVC	●	65	Cobalt blue	Box	72	H090034820	E-PT30-RC-B72	PTR-30C	0.37	30	30	100
	PVC		65	Dark green	Box	72	H090034763	E-PT30-SD-B72	PTS-30D	0.37	30	30	100
	PVC		65	Anthracite	Box	72	H090034163	E-PT30-SA-B72	PTS-30A	0.37	30	30	100
40	TPU	●	85	Cobalt blue	Box	60	H090060146	E-PT40-FC-B60	PTF-40C	0.48	30	40	110
	TPU	●	85	Green	Box	60	H090035266	E-PT40-FG-B60	PTF-40G	0.48	30	40	110
	TPU	●	85	White	Box	60	H090035166	E-PT40-FW-B60	PTF-40W	0.48	30	40	110
	PVC	●	65	White	Box	60	H090060072	E-PT40-RW-B60	PTR-40W	0.48	30	40	100
	PVC	●	65	Cobalt blue	Box	60	H950019715	E-PT40-RC-B60	PTR-40C	0.48	30	40	100
	PVC		65	Dark green	Box	60	H090034766	E-PT40-SD-B60	PTS-40D	0.48	30	40	100
	PVC		65	Anthracite	Box	60	H090034166	E-PT40-SA-B60	PTS-40A	0.48	30	40	100
50	TPU	●	85	Cobalt blue	Box	36	H090060147	E-PT50-FC-B36	PTF-50C	0.75	35	50	140
	TPU	●	85	Green	Box	36	H090035269	E-PT50-FG-B36	PTF-50G	0.75	35	50	140
	TPU	●	85	White	Box	36	H090035169	E-PT50-FW-B36	PTF-50W	0.75	35	50	140
	PVC	●	65	Dark green	Box	36	H090060109	E-PT50-RD-B36	PTR-50D	0.75	35	50	120
	PVC	●	65	Cobalt blue	Box	36	H090034821	E-PT50-RC-B36	PTR-50C	0.75	35	50	120
	PVC	●	65	White	Box	36	H090034813	E-PT50-RW-B36	PTR-50W	0.75	35	50	120
	PVC		65	Dark green	Box	36	H090034769	E-PT50-SD-B36	PTS-50D	0.75	35	50	120
	PVC		65	Anthracite	Box	36	H090034169	E-PT50-SA-B36	PTS-50A	0.75	35	50	120
70	TPU	●	85	Cobalt blue	Box	24	H090060148	E-PT70-FC-B24	PTF-70C	1	40	70	170
	TPU	●	85	Green	Box	24	H090035275	E-PT70-FG-B24	PTF-70G	1	40	70	170
	TPU	●	85	White	Box	24	H090035175	E-PT70-FW-B24	PTF-70W	1	40	70	170
	PVC	●	65	Dark green	Box	24	H090060110	E-PT70-RD-B24	PTR-70D	1	40	70	150
	PVC	●	65	Cobalt blue	Box	24	H090034822	E-PT70-RC-B24	PTR-70C	1	40	70	150
	PVC	●	65	White	Box	24	H090034814	E-PT70-RW-B24	PTR-70W	1	40	70	150
	PVC		65	Dark green	Box	24	H090034775	E-PT70-SD-B24	PTS-70D	1	40	70	150
	PVC		65	Anthracite	Box	24	H090034175	E-PT70-SA-B24	PTS-70A	1	40	70	150

PS

Height [mm]	Material	Food grade	Hardness [SHA]	Color	Package type	Package quantity	Order code	Product name	Description	Specific weight [kg/m]	B [mm]	H [mm]	Transversal pulley Ø [mm]
3	TPU+	●	87	Cobalt blue	Box	144	H090035186	E-PS03-HC-B144	PSH-75C	×	15	75	150
	TPU+	●	87	White	Box	144	H090037287	E-PS03-HW-B144	PSH-75W	×	15	75	150
4	TPU+	●	87	Cobalt blue	Box	144	H090035171	E-PS04-HC-B144	PSH-100C	0.7	15	100	150
	TPU+	●	87	White	Box	144	H090035170	E-PS04-HW-B144	PSH-100W	0.7	15	100	150
6	TPU+	●	87	Cobalt blue	Box	72	H090035187	E-PS06-HC-B72	PSH-150C	×	15	150	150
	TPU+	●	87	White	Box	72	H090037288	E-PS06-HW-B72	PSH-150W	×	15	150	150

PQ

Height [mm]	Material	Food grade	Hardness [SHA]	Color	Package type	Package quantity	Order code	Product name	Description	Specific weight [kg/m]	B [mm]	H [mm]	Transversal pulley Ø [mm]	Longitudinal pulley Ø [mm]
4	TPU	●	85	Cobalt blue	Coil	200	H090060140	E-PQ04-FC-C200	PQF-4C	0.04	8	4	30	40
	TPU	●	85	White	Box	540	H090035105	E-PQ04-FW-B540	PQF-4W (Box)	0.04	8	4	30	40
	TPU	●	85	White	Coil	200	H090035104	E-PQ04-FW-C200	PQF-4W	0.04	8	4	30	40
	PVC		65	Anthracite	Coil	200	H090034104	E-PQ04-SA-C200	PQS-4A	0.04	8	4	30	60
8	TPU+	●	83	Cobalt blue	Box	300	H090035118	E-PQ08-GC-B300	PQH-8C	0.08	8	8	50	110
	TPU+	●	83	White	Box	300	H090035111	E-PQ08-GW-B300	PQH-8W	0.08	8	8	50	110
	TPU	●	85	Cobalt blue	Coil	100	H090060153	E-PQ08-FC-C100	PQF-8C	0.08	8	8	50	110
	TPU	●	85	Green	Box	300	H090035209	E-PQ08-FG-B300	PQF-8G (Box)	0.08	8	8	50	110
	TPU	●	85	Green	Coil	100	H090035208	E-PQ08-FG-C100	PQF-8G	0.08	8	8	50	110
	TPU	●	85	White	Box	300	H090035109	E-PQ08-FW-B300	PQF-8W (Box)	0.08	8	8	50	110
	TPU	●	85	White	Coil	100	H090035108	E-PQ08-FW-C100	PQF-8W	0.08	8	8	50	110
	TPO	●	85	White	Coil	100	H090035145	E-PQ08-CW-C100	PQC-8W	×	×	×	×	×
	PVC	●	65	Cobalt blue	Box	300	H090034817	E-PQ08-RC-B300	PQR-8C (Box)	0.08	8	8	40	80
	PVC	●	65	Cobalt blue	Coil	100	H090034816	E-PQ08-RC-C100	PQR-8C	0.08	8	8	40	80
	PVC	●	65	White	Box	300	H090034808	E-PQ08-RW-B300	PQV-8W (Box)	0.08	8	8	40	80
	PVC	●	65	White	Coil	100	H090034807	E-PQ08-RW-C100	PQR-8W	0.08	8	8	40	80
	PVC		65	Dark green	Box	300	H090034709	E-PQ08-SD-B300	PQS-8D (Box)	0.08	8	8	40	80
	PVC		65	Dark green	Coil	100	H090034708	E-PQ08-SD-C100	PQS-8D	0.08	8	8	40	80
	PVC		65	Anthracite	Box	300	H090034109	E-PQ08-SA-B300	PQS-8A (Box)	0.08	8	8	40	80
	PVC		65	Anthracite	Coil	100	H090034108	E-PQ08-SA-C100	PQS-8A	0.08	8	8	40	80

× Data available on request

PQ cont.

Height [mm]	Material	Food grade	Hardness [SHA]	Color	Package type	Package quantity	Order code	Product name	Description	Specific weight [kg/m]	B [mm]	H [mm]	Transversal pulley Ø [mm]	Longitudinal pulley Ø [mm]
12	TPU+	●	83	Cobalt blue	Box	150	H090035120	E-PQ12-GC-B150	PQH-12C	0.17	12	12	70	140
	TPU+	●	83	White	Box	150	H090035119	E-PQ12-GW-B150	PQH-12W	0.17	12	12	70	140
	TPU	●	85	Dark green	Box	150	S090035503	E-PQ12-FD-B150	PQF-12D	0.12	12	12	70	140
	TPU	●	85	Green	Box	150	H090035213	E-PQ12-FG-B150	PQF-12G (Box)	0.12	12	12	70	140
	TPU	●	85	Green	Coil	50	H090035212	E-PQ12-FG-C50	PQF-12G	0.12	12	12	70	140
	TPU	●	85	White	Box	150	H090035113	E-PQ12-FW-B150	PQF-12W (Box)	0.12	12	12	70	140
	TPU	●	85	White	Coil	50	H090035112	E-PQ12-FW-C50	PQF-12W	0.12	12	12	70	140
	TPU	●	85	Cobalt blue	Box	150	H090034824	E-PQ12-FC-B150	PQF-12C (Box)	0.12	12	12	70	140
	TPU	●	85	Cobalt blue	Coil	50	H090034823	E-PQ12-FC-C50	PQF-12C	0.12	12	12	70	140
	PVC	●	65	Cobalt blue	Box	150	H090034819	E-PQ12-RC-B150	PQR-12C (Box)	0.12	12	12	70	130
	PVC	●	65	Cobalt blue	Coil	50	H090034818	E-PQ12-RC-C50	PQR-12C	0.12	12	12	70	130
	PVC	●	65	White	Box	150	H090034810	E-PQ12-RW-B150	PQR-12W (Box)	0.12	12	12	70	130
	PVC	●	65	White	Coil	50	H090034809	E-PQ12-RW-C50	PQR-12W	0.12	12	12	70	130
	PVC		65	Dark green	Box	150	H090034713	E-PQ12-SD-B150	PQS-12D (Box)	0.12	12	12	70	130
	PVC		65	Dark green	Coil	50	H090034712	E-PQ12-SD-C50	PQS-12D	0.12	12	12	70	130
	PVC		65	Anthracite	Box	150	H090034113	E-PQ12-SA-B150	PQS-12A (Box)	0.12	12	12	70	130
PVC		65	Anthracite	Coil	50	H090034112	E-PQ12-SA-C50	PQS-12A	0.12	12	12	70	130	
16	TPU+	●	83	Cobalt blue	Box	150	H090035122	E-PQ16-GC-B150	PQH-16C (Box)	0.23	12	16	80	160
	TPU+	●	83	White	Box	150	H090035121	E-PQ16-GW-B150	PQH-16W (Box)	0.23	12	16	80	160
	TPU	●	85	Green	Box	150	H090035217	E-PQ16-FG-B150	PQF-16G (Box)	0.17	12	16	80	160
	TPU	●	85	Green	Coil	50	H090035216	E-PQ16-FG-C50	PQF-16G	0.17	12	16	80	160
	TPU	●	85	White	Box	150	H090035117	E-PQ16-FW-B150	PQF-16W (Box)	0.17	12	16	80	160
	TPU	●	85	White	Coil	50	H090035116	E-PQ16-FW-C50	PQF-16W	0.17	12	16	80	160
	PVC	●	65	Cobalt blue	Coil	50	H090060106	E-PQ16-RC-C50	PQR-16C	0.17	12	16	80	160
	PVC	●	65	White	Box	150	H090060069	E-PQ16-RW-B150	PQV-16W (Box)	0.17	12	16	80	160
	PVC	●	65	White	Coil	50	H090060068	E-PQ16-RW-C50	PQR-16W	0.17	12	16	80	160
	PVC	●	65	Cobalt blue	Box	50	H090034829	E-PQ16-RC-B50	PQV-16C (Box)	0.17	12	16	80	160
	PVC		65	Dark green	Box	150	H090034717	E-PQ16-SD-B150	PQS-16D (Box)	0.17	12	16	80	160
	PVC		65	Dark green	Coil	50	H090034716	E-PQ16-SD-C50	PQS-16D	0.17	12	16	80	160
PVC		65	Anthracite	Box	150	H090034117	E-PQ16-SA-B150	PQS-16A (Box)	0.17	12	16	80	160	
PVC		65	Anthracite	Coil	50	H090034116	E-PQ16-SA-C50	PQS-16A	0.17	12	16	80	160	

PN

Height [mm]	Material	Food grade	Hardness [SHA]	Color	Package type	Package quantity	Order code	Product name	Description	Specific weight [kg/m]	B [mm]	H [mm]	Transversal pulley Ø [mm]
20	TPU	●	85	Dark green	Box	144	H090037220	E-PN20-FD-B144	PNT-20D	0.08	10	20	50
	TPU	●	85	Cobalt blue	Box	144	H090035366	E-PN20-FC-B144	PNF-20C	0.08	10	20	50
	TPU	●	85	Green	Box	144	H090035360	E-PN20-FG-B144	PNF-20G	0.08	10	20	50
	TPU	●	85	White	Box	144	H090035350	E-PN20-FW-B144	PNF-20W	0.08	10	20	50
30	TPU+	●	85	Cobalt blue	Box	100	H090035357	E-PN30-HC-B100	PNH-30C	0.12	10	30	50
	TPU+	●	85	White	Box	100	H090035356	E-PN30-HW-B100	PNH-30W	0.12	10	30	50
	TPU	●	85	Cobalt blue	Box	100	H090060141	E-PN30-FC-B100	PNF-30C	0.12	10	30	50
	TPU	●	85	Dark green	Box	100	H090037223	E-PN30-FD-B100	PNT-30D	0.12	10	30	50
	TPU	●	85	Green	Box	100	H090035361	E-PN30-FG-B100	PNF-30G	0.12	10	30	50
	TPU	●	85	White	Box	100	H090035351	E-PN30-FW-B100	PNF-30W	0.12	10	30	50
40	TPU	●	85	Dark green	Box	60	H090037226	E-PN40-FD-B60	PNT-40D	0.15	10	40	50
	TPU	●	85	Green	Box	60	H090035362	E-PN40-FG-B60	PNF-40G	0.15	10	40	50
	TPU	●	85	White	Box	60	H090035352	E-PN40-FW-B60	PNF-40W	0.15	10	40	50
	TPU	●	85	Cobalt blue	Box	60	H090034825	E-PN40-FC-B60	PNF-40C	0.15	10	40	50
60	TPU+	●	85	Cobalt blue	Box	43	H090035367	E-PN60-HC-B43	PNH-60C	0.24	10	60	50
	TPU+	●	85	White	Box	43	H090035365	E-PN60-HW-B43	PNH-60W	0.24	10	60	50
	TPU	●	85	Cobalt blue	Box	43	H090037235	E-PN60-FC-B43	PNF-60C	0.24	10	60	50
	TPU	●	85	Dark green	Box	43	H090037231	E-PN60-FD-B43	PNT-60D	0.24	10	60	50
	TPU	●	85	Green	Box	43	H090035364	E-PN60-FG-B43	PNF-60G	0.24	10	60	50
	TPU	●	85	White	Box	43	H090035354	E-PN60-FW-B43	PNF-60W	0.24	10	60	50
80	TPU	●	85	Cobalt blue	Box	36	S090037234	E-PN80-FC-B36	PNF-80C	0.34	10	80	50
	TPU	●	85	Green	Box	36	H090060143	E-PN80-FG-B36	PNF-80G	0.34	10	80	50
	TPU	●	85	White	Box	36	H090060142	E-PN80-FW-B36	PNF-80W	0.34	10	80	50
	TPU	●	85	Dark green	Box	36	H090037233	E-PN80-FD-B36	PNT-80D	0.34	10	80	50

PI

Height [mm]	Material	Food grade	Hardness [SHA]	Color	Package type	Package quantity	Order code	Product name	Description	Specific weight [kg/m]	B [mm]	H [mm]	Transversal pulley Ø [mm]
105	PVC	●	65	Dark green	Box	500	H090035178	E-PI105-RD-B500	PFR-105D	0.02	20	105	60
	PVC	●	65	Cobalt blue	Box	500	H090035177	E-PI105-RC-B500	PFR-105C	0.02	20	105	60
	PVC	●	65	White	Box	500	H090035176	E-PI105-RW-B500	PFR-105W	0.02	20	105	60

PB

Height [mm]	Material	Food grade	Hardness [SHA]	Color	Package type	Package quantity	Order code	Product name	Description	Specific weight [kg/m]	B [mm]	H [mm]	Transversal pulley Ø [mm]
20	TPU	●	85	Cobalt blue	Box	120	H090060149	E-PB20-FC-B120	PBF-20C	0.11	12	20	50
	TPU	●	85	White	Box	120	H090037280	E-PB20-FW-B120	PBF-20W	0.11	12	20	50
	TPU+	●	85	Dark green	Box	120	H090037237	E-PB20-FD-B120	PBT-20D	0.11	12	20	50
30	TPU	●	85	Cobalt blue	Box	84	H090060150	E-PB30-FC-B84	PBF-30C	0.15	12	30	50
	TPU	●	85	White	Box	84	H090037281	E-PB30-FW-B84	PBF-30W	0.15	12	30	50
	TPU+	●	85	Dark green	Box	84	H090037238	E-PB30-FD-B84	PBT-30D	0.15	12	30	50
40	TPU	●	85	Cobalt blue	Box	60	H090060151	E-PB40-FC-B60	PBF-40C	0.19	12	40	50
	TPU	●	85	White	Box	60	H090037282	E-PB40-FW-B60	PBF-40W	0.19	12	40	50
	TPU+	●	85	Dark green	Box	60	H090037239	E-PB40-FD-B60	PBT-40D	0.19	12	40	50
50	TPU	●	85	Cobalt blue	Box	48	H090060152	E-PB50-FC-B48	PBF-50C	0.25	12	50	50
	TPU	●	85	White	Box	48	H090037283	E-PB50-FW-B48	PBF-50W	0.25	12	50	50
	TPU+	●	85	Dark green	Box	48	H090037240	E-PB50-FD-B48	PBT-50D	0.25	12	50	50

Tracking guides

PV

Width [mm]	Material	Food grade	Hardness [SHA]	Color	Package type	Package quantity	Order code	Part number	Description	Specific weight [kg/m]	B [mm]	H [mm]	Conv. side transversal pulley Ø [mm]	Conv. side longitudinal pulley Ø [mm]	Running side longitudinal pulley Ø [mm]
6	TPU+	●	83	White	Coil	300	H090035182	E-PV06-GW-C300	PVH-6W	0.03	6	4	60	70	60
	TPU+	●	83	Cobalt blue	Coil	300	H090035180	E-PV06-GC-C300	PVH-6C	0.03	6	4	60	70	60
	TPU		65	Transparent	Coil	300	H090035150	E-PV06-WT-C300	PVU-6T	0.03	6	4	30	80	50
	TPU	●	85	White	Coil	200	H090060078	E-PV06-FW-C200	PVF-6W	0.03	6	4	×	50	40
	TPEE	●	55	White	Coil	200	H090035144	E-PV06-EW-C200	PVE-6W	×	×	×	×	×	×
	PVC	●	65	Cobalt blue	Coil	300	H090060116	E-PV06-RC-C300	PVR-6C	0.03	6	4	30	70	40
	PVC	●	65	Dark green	Coil	300	H090060111	E-PV06-RD-C300	PVR-6D	0.03	6	4	30	70	40
	PVC	●	65	White	Coil	300	H090060065	E-PV06-RW-C300	PVR-6W	0.03	6	4	30	70	40
	PVC		65	Dark green	Coil	300	H090034727	E-PV06-SD-C300	PVS-6D	0.03	6	4	30	70	40
	PVC		65	Anthracite	Coil	300	H090034126	E-PV06-SA-C300	PVS-6A	0.03	6	4	30	70	40
8	TPU+	●	83	White	Coil	200	H090035185	E-PV08-GW-C200	PVH-8W	0.04	8	5	70	90	70
	TPU+	●	83	Cobalt blue	Coil	200	H090035181	E-PV08-GC-C200	PVH-8C	0.04	8	5	70	90	70
	TPU		65	Transparent	Coil	200	H090035140	E-PV08-WT-C200	PVU-8T	×	×	×	×	×	×
	TPU	●	85	White	Coil	200	H090035129	E-PV08-FW-C200	PVF-8W	0.04	8	5	50	80	50
	TPU	●	85	Cobalt blue	Coil	200	H090034826	E-PV08-FC-C200	PVF-8C	0.04	8	5	50	80	50
	TPEE	●	55	White	Coil	200	H090035147	E-PV08-EW-C200	PVE-8W	×	×	×	×	×	×
	PVC	●	65	Cobalt blue	Coil	200	H090060117	E-PV08-RC-C200	PVR-8C	0.04	8	5	40	100	50
	PVC	●	65	Dark green	Coil	200	H090060112	E-PV08-RD-C200	PVR-8D	0.04	8	5	40	100	50
	PVC	●	65	White	Coil	200	H090060066	E-PV08-RW-C200	PVR-8W	0.04	8	5	40	100	50
	PVC		65	Dark green	Coil	200	H090034725	E-PV08-SD-C200	PVS-8D	0.04	8	5	40	100	50
PVC		65	Anthracite	Coil	200	H090034124	E-PV08-SA-C200	PVS-8A	0.04	8	5	40	100	50	

× Data available on request

PV cont.

Width [mm]	Material	Food grade	Hardness [SHA]	Color	Package type	Package quantity	Order code	Part number	Description	Specific weight [kg/m]	B [mm]	H [mm]	Conv. side transversal pulley Ø [mm]	Conv. side longitudinal pulley Ø [mm]	Running side longitudinal pulley Ø [mm]
10	TPU+	●	83	White	Coil	200	H090035183	E-PV10-GW-C200	PVH-10W	0.06	10	6	90	120	90
	TPU+	●	83	Cobalt blue	Coil	200	H090035179	E-PV10-GC-C200	PVH-10C	0.06	10	6	90	120	90
	TPU		65	Transparent	Coil	200	H090035151	E-PV10-WT-C200	PVU-10T	0.06	10	6	50	100	60
	TPU	●	85	Green	Coil	200	H090035230	E-PV10-FG-C200	PVF-10G	0.06	10	6	50	110	60
	TPU	●	85	White	Coil	200	H090035130	E-PV10-FW-C200	PVF-10W	0.06	10	6	50	110	60
	TPU	●	85	Cobalt blue	Coil	200	H090034827	E-PV10-FC-C200	PVF-10C	0.06	10	6	50	110	60
	TPEE	●	55	White	Coil	200	H090035148	E-PV10-EW-C200	PVD-10W	×	×	×	×	×	×
	PVC		55	Anthracite	Coil	200	H090034630	E-PV10-OA-C200	PVO-10A	0.06	10	6	40	100	50
	PVC	●	65	Cobalt blue	Coil	200	H090060118	E-PV10-RC-C200	PVR-10C	0.06	10	6	40	120	60
	PVC	●	65	Dark green	Coil	200	H090060113	E-PV10-RD-C200	PVR-10D	0.06	10	6	40	120	60
	PVC	●	65	White	Coil	200	H090034811	E-PV10-RW-C200	PVR-10W	0.06	10	6	40	120	60
	PVC		65	Dark green	Coil	200	H090034730	E-PV10-SD-C200	PVS-10D	0.06	10	6	40	120	60
	PVC		65	Anthracite	Coil	200	H090034130	E-PV10-SA-C200	PVS-10A	0.06	10	6	40	120	60
13	TPU+	●	83	White	Coil	100	H090035184	E-PV13-GW-C100	PVH-13W	0.1	13	8	120	150	120
	TPU+	●	83	Cobalt blue	Coil	100	H090035174	E-PV13-GC-C100	PVH-13C	0.1	13	8	120	150	120
	TPU		65	Transparent	Coil	100	H090035152	E-PV13-WT-C100	PVU-13T	0.1	13	8	80	120	80
	TPU	●	85	Green	Coil	100	H090035233	E-PV13-FG-C100	PVF-13G	0.1	13	8	80	140	80
	TPU	●	85	White	Coil	100	H090035133	E-PV13-FW-C100	PVF-13W	0.1	13	8	80	140	80
	TPU	●	85	Cobalt blue	Coil	100	H090034828	E-PV13-FC-C100	PVF-13C	0.1	13	8	80	140	80
	TPO	●	85	White	Coil	100	H090035146	E-PV13-CW-C100	PVC-13W	×	×	×	×	×	×
	TPEE	●	55	White	Coil	100	H090035142	E-PV13-EW-C100	PVE-13W	×	×	×	×	×	×
	PVC		55	Anthracite	Coil	100	H090034633	E-PV13-OA-C100	PVO-13A	0.1	13	8	70	140	60
	PVC	●	65	Cobalt blue	Coil	100	H090060119	E-PV13-RC-C100	PVR-13C	0.1	13	8	70	140	60
	PVC	●	65	Dark green	Coil	100	H090060114	E-PV13-RD-C100	PVR-13D	0.1	13	8	70	140	60
	PVC	●	65	White	Coil	100	H090034812	E-PV13-RW-C100	PVR-13W	0.1	13	8	70	140	60
	PVC		65	Dark green	Coil	100	H090034733	E-PV13-SD-C100	PVS-13D	0.1	13	8	70	150	80
PVC		65	Anthracite	Coil	100	H090034133	E-PV13-SA-C100	PVS-13A	0.1	13	8	70	150	80	
17	TPU		65	Transparent	Coil	50	H090035153	E-PV17-WT-C50	PVU-17T	0.15	17	11	120	140	120
	TPU	●	85	Green	Coil	50	H090035237	E-PV17-FG-C50	PVF-17G	0.15	17	11	120	160	120
	TPU	●	85	White	Coil	50	H090035137	E-PV17-FW-C50	PVF-17W	0.15	17	11	120	160	120
	TPEE	●	55	White	Coil	50	H090035143	E-PV17-EW-C50	PVD-17W	×	×	×	×	×	×
	PVC		55	Anthracite	Coil	50	H090034637	E-PV17-OA-C50	PVO-17A	0.15	17	11	100	160	100
	PVC	●	65	Cobalt blue	Coil	50	H090060120	E-PV17-RC-C50	PVR-17C	0.15	17	11	100	180	120
	PVC	●	65	Dark green	Coil	50	H090060115	E-PV17-RD-C50	PVR-17D	0.15	17	11	100	180	120
	PVC	●	65	White	Coil	50	H090060067	E-PV17-RW-C50	PVR-17W	0.15	17	11	100	180	120
	PVC		65	Dark green	Coil	50	H090034737	E-PV17-SD-C50	PVS-17D	0.15	17	11	100	180	120
PVC		65	Anthracite	Coil	50	H090034137	E-PV17-SA-C50	PVS-17A	0.15	17	11	100	180	120	
22	PVC		65	Anthracite	Coil	50	H090034142	E-PV22-SA-C50	PVS-22A	0.29	22	14	120	220	170
30	PVC		55	Anthracite	Coil	25	H090034650	E-PV30-OA-C25	PVO-30A	0.59	30	16	×	200	180
	PVC		65	Anthracite	Coil	25	H090034150	E-PV30-SA-C25	PVS-30A	0.59	30	16	×	250	200

× Data available on request

PV Notched

Width [mm]	Material	Food grade	Hardness [SHA]	Color	Package type	Package quantity	Order code	Part number	Description	Specific weight [kg/m]	B [mm]	H [mm]	Conv. side transversal pulley Ø [mm]	Conv. side longitudinal pulley Ø [mm]	Running side longitudinal pulley Ø [mm]
6	TPU+	●	83	Cobalt blue	Coil	300	H090060040	E-PV06-GC-C300+N	PVH-6C N						
	TPU+	●	83	White	Coil	300	H090060039	E-PV06-GW-C300+N	PVH-6W N						
	TPU		65	Natural	Coil	300	S090035159	E-PV06-WN-C300+N	PVU-6N	0.03	6	4	30	65	50
	PVC	●	65	White	Coil	300	H090060073	E-PV06-RW-C300+N	PVR-6W-N	0.03	6	4	30	60	40
	PVC		65	Anthracite	Coil	300	H090034128	E-PV06-SA-C300+N	PVS-6A-N	0.03	6	4	30	60	40
8	TPU	●	85	White	Coil	200	H090035128	E-PV08-FW-C200+N	PVF-8W-N	0.04	8	5	50	70	50
	PVC	●	65	White	Coil	200	H090060074	E-PV08-RW-C200+N	PVR-8W-N	0.04	8	5	40	80	40
	PVC		65	Dark green	Coil	200	H090034726	E-PV08-SD-C200+N	PVS-8D-N	0.04	8	5	40	80	40
	PVC		65	Anthracite	Coil	200	H090034125	E-PV08-SA-C200+N	PVS-8A-N	0.04	8	5	40	80	40
10	TPU		65	Transparent	Coil	200	H090035158	E-PV10-WT-C200+N	PVU-10T-N	0.05	10	6	50	80	60
	TPU	●	85	Green	Coil	200	H090035232	E-PV10-FG-C200+N	PVF-10G-N	0.05	10	6	50	90	60
	TPU	●	85	White	Coil	200	H090035132	E-PV10-FW-C200+N	PVF-10W-N	0.05	10	6	50	90	60
	PVC		55	Anthracite	Coil	200	H090034632	E-PV10-OA-C200+N	PVO-10A-N	0.06	10	6	40	90	40
	PVC	●	65	White	Coil	200	H090060075	E-PV10-RW-C200+N	PVR-10W-N	0.06	10	6	40	100	50
	PVC		65	Dark green	Coil	200	H090034732	E-PV10-SD-C200+N	PVS-10D-N	0.06	10	6	40	100	50
	PVC		65	Anthracite	Coil	200	H090034132	E-PV10-SA-C200+N	PVS-10A-N	0.06	10	6	40	100	50
13	TPU		65	Transparent	Coil	100	S090035156	E-PV13-WT-C100+N	PVU-13T-N	0.09	13	8	80	120	80
	TPU	●	85	Green	Coil	100	H090035234	E-PV13-FG-C100+N	PVF-13G-N	0.09	13	8	80	120	80
	TPU	●	85	White	Coil	100	H090035135	E-PV13-FW-C100+N	PVF-13W-N	0.09	13	8	80	120	80
	PVC		55	Anthracite	Coil	100	H090034635	E-PV13-OA-C100+N	PVO-13A-N	0.09	13	8	70	120	50
	PVC	●	65	White	Coil	100	H090060076	E-PV13-RW-C100+N	PVR-13W-N	0.09	13	8	70	130	60
	PVC		65	Dark green	Coil	100	H090034735	E-PV13-SD-C100+N	PVS-13D-N	0.09	13	8	70	130	60
	PVC		65	Anthracite	Coil	100	H090034135	E-PV13-SA-C100+N	PVS-13A-N	0.09	13	8	70	130	60
17	TPU		65	Transparent	Coil	50	H090035157	E-PV17-WT-C50+N	PVU-17T-SN	×	×	×	×	×	×
	TPU	●	85	White	Coil	55	H090060101	E-PV17-FW-C55+N	PVF-17W-N (Coil 55M)	0.13	17	11	120	140	120
	TPU	●	85	Green	Coil	50	H090035239	E-PV17-FG-C50+N	PVF-17G-N	0.13	17	11	120	140	120
	TPU	●	85	White	Coil	50	H090035139	E-PV17-FW-C50+N	PVF-17W-N	0.13	17	11	120	140	120
	TPU		92	White	Coil	50	H090035141	E-PV17-TW-C50+N	PVF-17W92-SN	×	×	×	×	×	×
	PVC		55	Anthracite	Coil	50	H090034639	E-PV17-OA-C50+N	PVO-17A-N	0.13	17	11	100	140	100
	PVC	●	65	White	Coil	50	H090060077	E-PV17-RW-C50+N	PVR-17W-N	0.13	17	11	100	160	100
	PVC		65	Dark green	Coil	50	H090034739	E-PV17-SD-C50+N	PVS-17D-N	0.13	17	11	100	160	100
	PVC		65	Anthracite	Coil	50	H090034139	E-PV17-SA-C50+N	PVS-17A-N	0.13	17	11	100	160	100
22	PVC		65	Anthracite	Coil	50	H090034144	E-PV22-SA-C50+N	PVS-22A-N	0.25	22	14	120	180	150
30	PVC		55	Anthracite	Coil	25	H090034652	E-PV30-OA-C25+N	PVO-30A-N	0.52	30	16	×	180	150
	PVC		65	Anthracite	Coil	25	H090034152	E-PV30-SA-C25+N	PVS-30A-N	0.52	30	16	×	200	160

× Data available on request

PV Special notched

Width [mm]	Material	Food grade	Hardness [SHA]	Color	Package type	Package quantity	Order code	Part number	Description	Specific weight [kg/m]	B [mm]	H [mm]	Conv. side transversal pulley Ø [mm]	Conv. side longitudinal pulley Ø [mm]	Running side longitudinal pulley Ø [mm]
6	TPU	●	92	White	Coil	300	H090060093	E-PV06-TW-C300+NN	PVY-6X4.0W92-SN	0.03	6	4	×	×	40
8	TPU+	●	83	White	Coil	200	H090060137	E-PV08-GW-C200+NN	PVH-8W-SN	0.04	8	5	×	60	30
	TPU+	●	83	Cobalt blue	Coil	200	H090060135	E-PV08-GC-C200+NN	PVH-8C-SN	0.04	8	5	×	60	30
	TPU	●	85	Cobalt blue	Coil	200	H090060123	E-PV08-FC-C200+NN	PVF-8C-SN	0.04	8	5	×	60	30
	TPU	●	85	White	Coil	200	H090035127	E-PV08-FW-C200+NN	PVF-8W-SN	0.04	8	5	×	60	30
10	TPU+	●	83	White	Coil	200	H090060138	E-PV10-GW-C200+NN	PVH-10W-SN	0.05	10	6	×	70	40
	TPU+	●	83	Cobalt blue	Coil	200	H090060133	E-PV10-GC-C200+NN	PVH-10C-SN	0.05	10	6	×	70	40
	TPU	●	85	Cobalt blue	Coil	200	H090060124	E-PV10-FC-C200+NN	PVF-10C-SN	0.05	10	6	×	70	40
	TPU	●	85	White	Coil	200	H090035131	E-PV10-FW-C200+NN	PVF-10W-SN	0.05	10	6	×	70	40
	TPU		92	White	Coil	200	H090060094	E-PV10-TW-C200+NN	PVY-10X5.0W92-SN	0.05	10	5	×	×	50
13	TPU+	●	83	Cobalt blue	Coil	100	H090060136	E-PV13-GC-C100+NN	PVH-13C-SN	0.09	13	8	×	90	50
	TPU+	●	83	White	Coil	100	H090060132	E-PV13-GW-C100+NN	PVH-13W-SN	0.09	13	8	×	90	50
	TPU	●	85	Cobalt blue	Coil	100	H090060125	E-PV13-FC-C100+NN	PVF-13C-SN	0.09	13	8	×	90	50
	TPU	●	85	White	Coil	100	H090035136	E-PV13-FW-C100+NN	PVF-13W-SN	0.09	13	8	×	90	50
	TPU		92	White	Coil	100	H090060095	E-PV13-TW-C100+NN	PVY-13X6.5W92-SN	0.09	13	6	×	×	65
17	TPU	●	85	Green	Coil	50	H090035173	E-PV17-FG-C50+NN	PVF-17G-SN	×	×	×	×	×	×
	TPU	●	85	White	Coil	50	H090035138	E-PV17-FW-C50+NN	PVF-17W-SN	0.13	17	11	×	100	60
3/8	TPU		92	White	Coil	200	H090060122	E-PV3/8-TW-C200+NN	PVY-9,7X6,1W92-SN	0.05	10	6	×	×	65
1/2	TPU		92	White	Coil	100	H090060103	E-PV1/2-TW-C100+NN	PVY-12,7X7,9W92-SN	0.07	13	8	×	×	80

PU

Width [mm]	Material	Food grade	Hardness [SHA]	Color	Package type	Package quantity	Order code	Part number	Description	Specific weight [kg/m]	B [mm]	H [mm]	Conv. side longitudinal pulley Ø [mm]	Running side longitudinal pulley Ø [mm]
15	TPU	●	85	White	Coil	50	H090060052	E-PU15-FW-C50	PUG 15/5W	0.15	15	5	40	40
25	TPU	●	85	White	Coil	50	H090060051	E-PU25-FW-C50	PUG 25/5W	0.17	25	5	40	40

× Data available on request

Tolerances

The general tolerance to be considered for the extruded products range is $\pm 3\%$ or ± 0.20 mm – whichever is greatest.

Shelf life

Due to the wide variety of product designs and storage conditions, no general recommendations on shelf life can be given. After two years in storage, a visual check of surface color and aspect (migration of plasticizers, fillers, uniformity, etc.) should be made.

Pulleys for round and V-belts

V-shaped belts comply with DIN 2215. Respective pulleys comply with DIN 2217

Belt tension

In order to ensure proper operation of the installed belt, pre-tensioning is required. The recommended elongation factor is from 1% to 8% depending on the belt shape and material (hardness). The initial tension is checked by making two reference marks on the un-tensioned belt at a certain distance apart x ($x = 100\%$). The marks should ideally be at both edges of the belt, but not where it is joined. The belt is then tensioned until the measuring marks have reached the required elongation ($x + \epsilon_0$).

Example: Required initial tension $\epsilon_0 = 0.5\%$, distance between marks before tensioning $x = 1000$ mm, distance between marks after tensioning $x + \epsilon_0 = 1000$ mm + 5 mm = 1005 mm. Once the belt has completed at least one circuit of the installation, the distance ($x + \epsilon_0$) must be measured again and corrected where necessary.

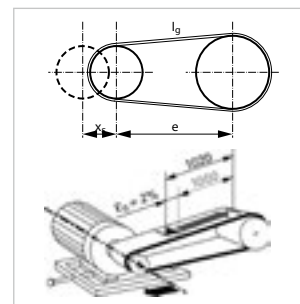

Good to know about tracking guides

Guiding profiles are usually V-shaped or are flat profiles welded onto the running side of the conveyor belt. They are employed for two fundamentally different functions: 1) as a general belt tracking measure, and 2) as a measure to absorb transverse forces. Suggested groove dimensions are: sliding beds or carrying rollers = profile width + 4 mm drive pulleys = profile width + 10 mm

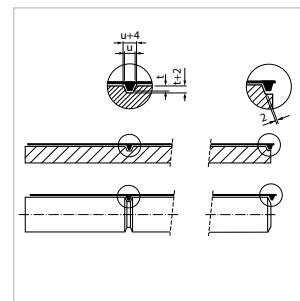

Belt type	Suggested initial tension [%]
Round belts (not reinforced)	6-8%*
Round belts (reinforced)	1%
V-shaped belts (not reinforced)	3%
V-shaped belts (reinforced)	1%
TT belts	3-4%

* Install the slack belt and tension until running perfectly under the full round belt load, without exceeding 6–8%.

Quickmelt joining system for Polycord® round belts

Thanks to handy Habasit joining tools, customers can join Polycord® round belts themselves.

Cutting

- If take-up x is available and sufficient for the required take-up x_{ϵ} , measure and cut off a belt length l_1 (e.g. 2500 mm) determined by a string in the pulley grooves at the shortest center distance.
- If no take-up x is available, proceed as above, but deduct initial tension $\epsilon = 8\%$ (e.g. 200 mm in case of a belt length of 2500 mm) and measure a net belt length l_3 of 2300 mm.



Joining

See the operating instructions of the respective joining device for the exact procedure. Joining Polycord round belts is very simple (illustration: welding device PQ-01):

- Clamp the belt ends into the welding device
- Allow them to melt against the heating blade (do not inhale the vapor; join only in well-ventilated areas)
- Then put the belt ends together and let the joint cool off
- Trim any swelling with pliers, a file, or a grinding wheel

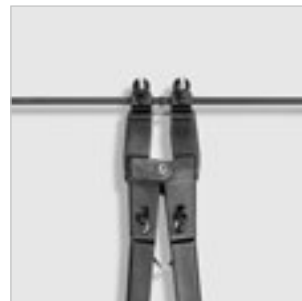

Installing

- If take-up x is available and sufficient for the required take-up x_{ϵ} , trace two measuring marks at a distance of 1000 mm (or 500 mm) on the belt. Tension it using the generally applicable initial tensioning value $\epsilon = 8\%$ by increasing the center distance. The distance between the two measuring marks should now be 1080 mm (or 540 mm).
- If no take-up x is available, install the belt first on the small pulley, then "force" it onto the larger pulley by carefully turning the drive by hand.

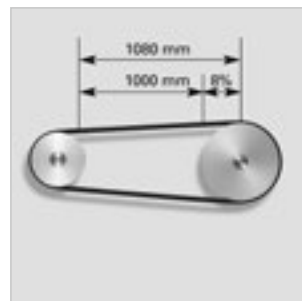

S-16

Manual scissors for cutting round belts, up to 15 mm in diameter. Ideal for Polycord, Habicord, and small section extruded profiles.



Details				Power supply					Product type						Method			Dimensions					
Product name	Max. belt width	Ordering code	Article name	Power [W]	Manual	1 x 120 V	1 x 230 V	3 x 230 V	3 x 400 V	Timing belts	Conveyor belts	Habasit® Cleandrive	Round belts	Power transmission	Machine tapes	Joining plate required	Flexproof	Quickmelt	Thermofix	Length [mm]	Width [mm]	Height [mm]	Weight [kg]
S-16	15	H080690010	S-16/0		•								•					•		220	80	55	1

Key to symbols

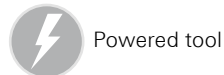
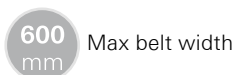

PQ-01

Quickmelt welding tool, designed for joining round belts. It consists of a W-01 welder and CQ-01 table stand for belt ends positioning.



PQ-02

Quickmelt welding tool, designed for joining round belts. It consists of a W-01 welder and CQ-02 clamping device.



W-01

The W-01 heating welder has been specifically designed for rapid and safe welding of thermoplastic round belts up to a diameter of 15 mm.



Details				Power supply					Product type					Method			Dimensions						
Product name	Max. belt width	Ordering code	Article name	Power [W]	Manual	1 x 120 V	1 x 230 V	3 x 230 V	3 x 400 V	Timing belts	Conveyor belts	Habasit® Cleandrive	Round belts	Power transmission	Machine tapes	Joining plate required	Flexproof	Quickmelt	Thermofix	Length [mm]	Width [mm]	Height [mm]	Weight [kg]
PQ-01	15	H088000526	PQ-01/8	80			•						•				•			420	140	120	1
PQ-01	15	H088000525	PQ-01/6	80	•								•				•			420	140	120	1
PQ-02	15	H088000541	PQ-02/8	80			•						•				•			420	140	120	1
PQ-02	15	H088000540	PQ-02/6	80	•								•				•			420	140	120	1
W-01	15	H08N060965	W-01/8	80			•						•				•			250	50	50	1
W-01	15	H088000540	W-01/6	80	•								•				•			250	50	50	1

Customers first

Your success is our goal. That is why we don't just offer products; we provide solutions. As committed partners to our customers, we are dedicated to sharing our knowledge and providing full support.

Since our founding in 1946, Habasit has been finding ways to meet customer-specific needs in every application. This is what differentiates us as the #1 worldwide belting provider in the industry today.



Comprehensive consulting and technical support

Profit from the best consulting and technical support in the lightweight belting industry. Local experts are always available to assist you with your belting needs. The Habasit team is proud to provide the highest level of support, together with top-quality products that have led the global market for decades.



Belt selection and calculation assistance

We are always glad to help you select the most suitable belt for any application for your convenience. We now also provide the free online tool 'SeleCalc' which allows you to easily make selections and calculations yourself. Simply register online at selecalc.habasit.com.



Fabrication, assembly and local installation services

As a full-service belting provider, we offer joining and assembly services either at our own locations or directly on your equipment.

Habasit has over 30 affiliates worldwide, each with its own inventory, fabrication, assembly and service facilities.



Together with representative offices and numerous qualified distributors, we can react quickly and efficiently to meet all your needs.



Customer training programs

To ensure the optimal performance and maximum lifespan of all our products, we offer training programs and various support tools. This includes proper procedures for fabrication, installation, assembly, maintenance and belt repair, all of which take place at a Habasit site or at your location.



Belt monitoring, inspections, analyses and process optimization proposals

We organize and handle belt maintenance, inspections, analyses and surveys at customers' sites. Upon request, we are ready to develop optimization proposals to ensure you're getting maximum value from your machinery and process output.



Design assistance for customized solutions

Habasit believes in building partnerships with our customers. Our engineering team will work closely with your engineers on joint design developments from initial design to final implementation. This expert service can be invaluable for projects involving new technologies or large-scale modifications and adaptations.



Committed to innovation

Because our customers' belting challenges and needs are always changing, we consistently invest a substantial amount of labor and resources into the research and development of new products and solutions.

Certified for quality

We deliver the highest quality standards not only in our products and solutions, but also in our employees' daily work processes. Habasit AG is certified according to ISO 9001:2015.



Worldwide leading product range

Habasit offers the largest selection of belting, conveying, processing and complementary products in the industry. Our response to any request is nothing less than a specific, tailor-made solution.



HabaFLOW®
Fabric-based conveyor and processing belts



HabasitLINK®
Plastic modular belts

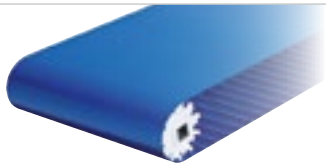

Habasit® Cleandrive
Monolithic reinforced conveyor belts



HabaDRIVE®
Power transmission belts



HabaSYNC®
Timing belts



HabasitCHAIN®
Chains (slat and conveyor chains)



Machine tapes



Round belts



Seamless belts



HabiPLAST
Profiles, Guides, Wear strips



Accessories
(sprockets, flights, welding profiles, etc.)



Fabrication tools
(joining, cutting & preparing devices)

Notes

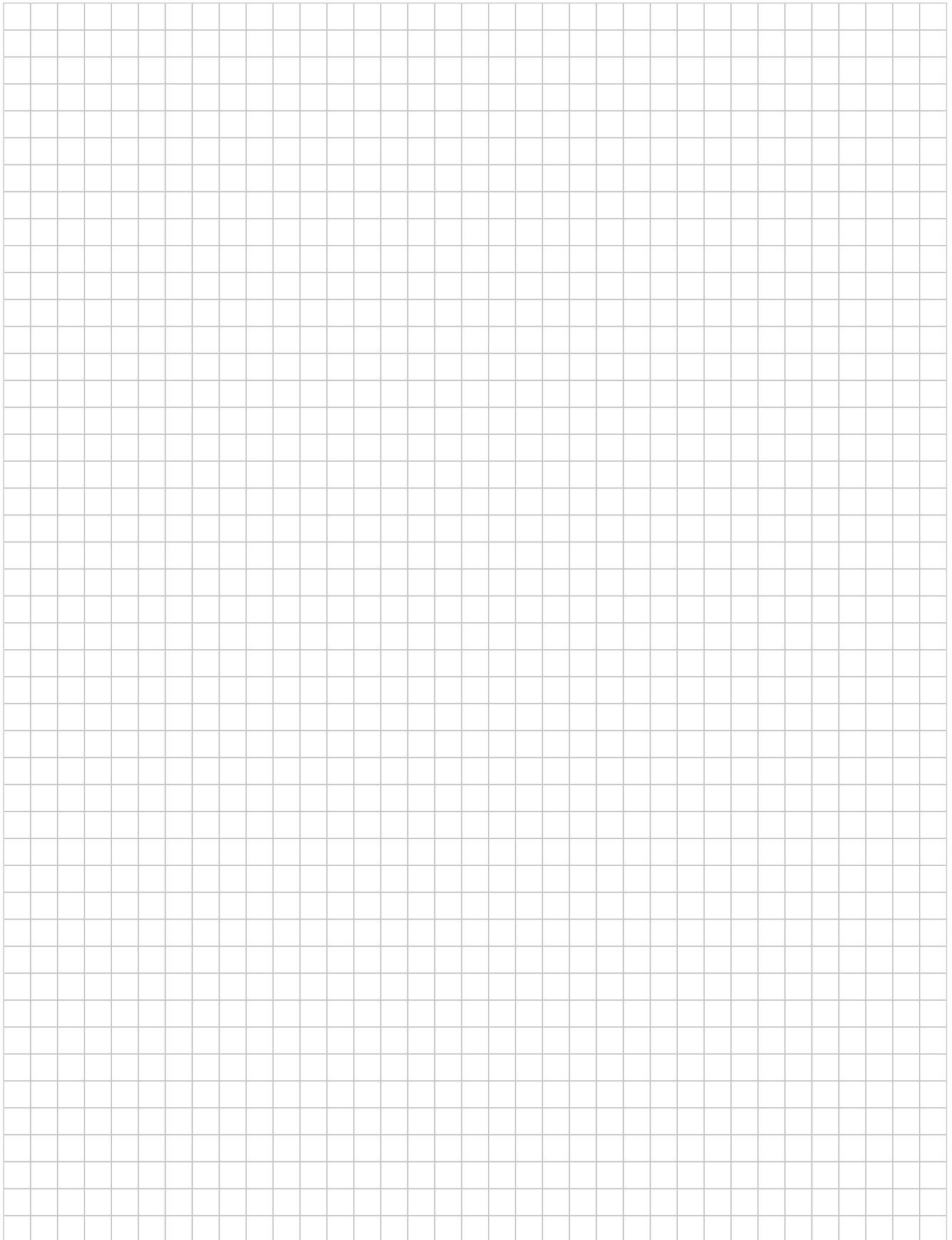

Notes

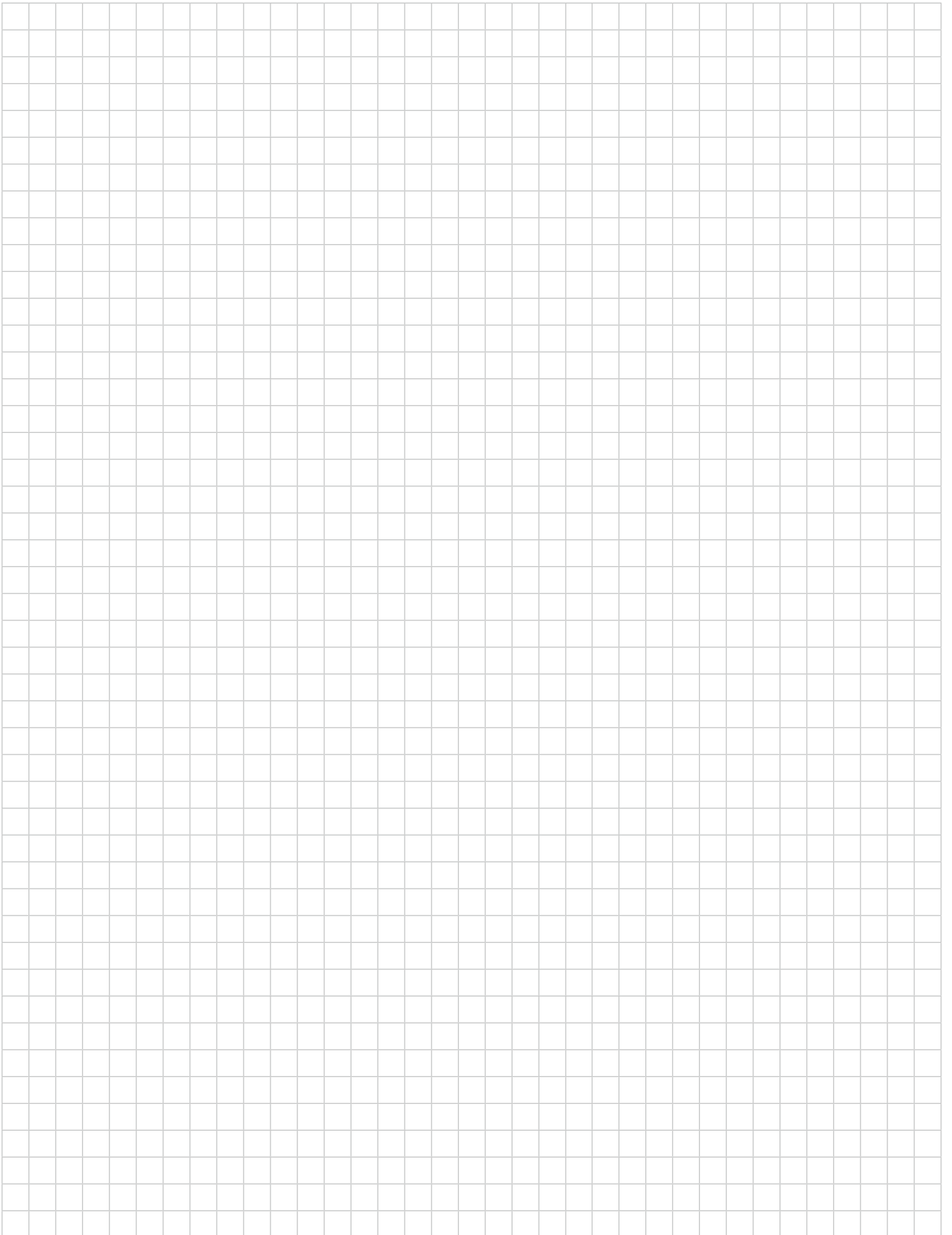

Australia

Habasit Australia Pty Ltd.
Silverwater, Sydney
Phone: +61 1300 945 455
www.habasit.com.au

Austria

Habasit GmbH, Wiener Neudorf
Phone: +43 1 690 66
www.habasit.at

Belgium & Luxembourg

Habasit Belgium N.V., Zaventem
Phone: +32 27 250 430
www.habasit.be | habasit.lu

Brazil

Habasit do Brasil, Barueri - SP
Phone: +55 11 4789 9022
www.habasit.com.br

Canada

Habasit Canada Ltd., Oakville
Phone: +1 905 827 41 31
www.habasit.ca

China

Habasit East Asia Ltd.
Fotan, Shatin, N.T., Hong Kong
Phone: +852 2145 0150
www.habasit.com.hk

Habasit (Shanghai) Co. Ltd.
Shanghai
Phone: +8621 5488 1218
www.habasit.com.cn

France

Habasit France SAS, Mulhouse
Phone: +33 3 89 33 89 03
www.habasit.fr

Germany

Habasit GmbH, Eppertshausen
Phone: +49 6071 969 0
www.habasit.de

India

Habasit India, Coimbatore
Phone: +91 422 666 78 00
www.habasit.in

Italy

Habasit Italiana SpA
Customer Care: 0438 911333
For int. calls: +39 0438 911444
www.habasit.it

Japan

Habasit Nippon Co., Ltd., Tokyo
Phone: +81 120 07 6339
www.habasit.co.jp

Korea (Republic of)

Habasit Korea Ltd., Seongnam
Phone: +82 31 737 9370
www.habasit.co.kr

Mexico

Habasit Rocua, Zapopan
Phone: +52 33 3824 2358
www.habasitrocu.mx

Netherlands

Habasit Netherlands BV, Nijkerk
Phone: +31 332 472 030
www.habasit.nl

New Zealand

Habasit New Zealand Pty Ltd.
Auckland
Phone: 0800 000 070
www.habasit.co.nz

Nordic countries

Habasit AB, Hindås, Sweden
Phone: +46 301 226 00
www.habasit.se

Poland

Habasit Polska Sp. z o.o.
Dąbrowa Górnicza
Phone: +48 32 639 02 40
www.habasit.pl

Russia

OOO Habasit Ltd.
Moscow Region
Phone: +7 495 966 1566
www.habasit.ru

Singapore

Habasit Far East Pte Ltd.
Singapore
Phone: +65 6862 5566
www.habasit.com.sg

South Africa

Habasit South Africa Pty Ltd.
Gauteng
Phone: +27 10 001 6770
www.habasit.co.za

Spain

Habasit Hispánica S.A.
Barberá del Vallés
Phone: +34 937 191 912
www.habasit.es

Switzerland

Habasit GmbH, Reinach
Phone: +41 61 577 51 00
www.habasit.ch

Taiwan

Habasit (Taiwan) Ltd.
New Taipei City
Phone: +886 2 2267 0538
www.habasit.com.tw

Turkey

Habasit Kayis San.
Ve Tic. Ltd. Sti., Istanbul
Phone: +90 444 70 43
www.habasit.com.tr

Ukraine

Habasit Ukraine LLC., Kyiv
Phone: +38 044 290 88 99
www.habasit.ua

United Kingdom & Ireland

Habasit UK Ltd., Elland
Phone: +44 333 207 6570
www.habasit.co.uk

USA

Habasit America
Suwanee, Georgia
Phone: +1 800 458 6431
www.habasitamerica.com

Habasit International AG

Römerstrasse 1
CH-4153 Reinach, Switzerland
Phone +41 61 715 15 15
Fax +41 61 715 15 55
www.habasit.com

Registered trademarks
Copyright Habasit International AG
Subject to alterations
4299BRO.PRF-en1017ITA